









BOLINGBROOK, IL 815.886.9900	PALATINE, IL 847.991.7867	PERU, IL 815.224.3439	CHICAGO, IL 773.475.9000	ROCKDALE, IL 815.744.7800	AGAWAM, MA 413.789.6600	ALLENTOWN, PA 610.395.3718
DEEP RIVER, CT 860.526.5941	PORTLAND, OR 503.283.5615	ALBANY, OR 541.248.3802	BOCA RATON, FL 561.241.0242	CONCORD, NC 704.721.6661	WASHINGTON, DC 708.514.2016	VISIT US ONLINE: SeidelDiesel Group.com

**ALLIANT
POWER™**

LIGHT DUTY

FORD.....	4
7.3L POWER STROKE	6
6.0L & 4.5L POWER STROKE	18
6.4L POWER STROKE	34
6.7L POWER STROKE	44
NAVISTAR.....	52
T444E.....	54
VT365,VT275,MAXXFORCE5.....	62
MAXXFORCE 7.....	74
DT466E,I530E,DT466/530,HT530.....	82
PERKINS 1300 EDi, DETROIT DIESEL SERIES 40E.....	90
DT466/570, HT570, MAXXFORCE DT/9/10, N9/N10.....	92
GM.....	100
6.5L	102
6.6L.....	106
DODGE/CUMMINS.....	114
Engines with PT PUMPs.....	116
5.9L.....	117
6.7L.....	122
JEEP/SPRINTER.....	124
2.9L&3.0L.....	126



BOLINGBROOK, IL 815.886.9900	PALATINE, IL 847.991.7867	PERU, IL 815.224.3439	CHICAGO, IL 773.475.9000	ROCKDALE, IL 815.744.7800	AGAWAM, MA 413.789.6600	ALLENTOWN, PA 610.395.3718
DEEP RIVER, CT 860.526.5941	PORTLAND, OR 503.283.5615	ALBANY, OR 541.248.3802	BOCA RATON, FL 561.241.0242	CONCORD, NC 704.721.6661	WASHINGTON, DC 708.514.2016	VISIT US ONLINE: SeidelDiesel Group.com

TRADEMARKS

AGCO® is a registered trademark of AGCO Corporation

ARP® is a registered trademark of Automotive Racing Products, Inc.

Bosch® is a registered trademark licensed by Robert Bosch GmbH, Germany.

Caterpillar® and CAT® are registered trademarks of Caterpillar, Inc.

Cummins®, ISB®, and B-Series® are registered trademarks of Cummins Engine Company, Inc.

Detroit Diesel® and Series 50/60® are registered trademarks of Detroit Diesel Corporation.

Dodge® and Ram® are registered trademarks of Chrysler Group, LLC.

DMAC® is a registered trademark of DMAX Ltd.

Ford®, Motorcraft®, and Power Stroke® are registered trademarks of Ford Motor Company.

Freightliner® is a registered trademark of Daimler AG.

F Series®, F-250®, F-350®, F-450®, F-550®, F-650®, F-750®, E Series®, Econoline®, and Excursion®, are registered trademarks of Ford Motor Company.

GM®, GMC®, Chevrolet®, Chevy®, Duramax®, Express®, Savana®, Sierra®, Silverado® are registered trademarks of General Motors, LLC.

HEUI® is a registered trademark of Caterpillar, Inc.

IH® is a registered trademark of CNH America, LLC.

Isuzu® is a registered trademark of Isuzu Motors America LLC.

International® and MaxxForce® are registered trademarks of International Truck Intellectual Property Company, LLC.

Jeep®, Jeep Liberty®, and Jeep Grand Cherokee® are registered trademarks of Chrysler Group, LLC.

John Deere® is a registered trademark of Deere & Company.

Mack® and Mack Trucks® are registered trademarks of Volvo AB.

M-B®, OM®, and Mercedes-Benz® are registered trademarks of Daimler AG.

Navistar® is a registered trademark of Navistar International Corporation.

Perkins® and 1300 Series EDi® are registered trademarks of Perkins Engines Company Limited, a subsidiary of Caterpillar, Inc.

Racor® is a registered trademark of Parker Hannifin Corp.

Siemens® is a registered trademark of Siemens AG.

Sprinter® and/or Mercedes-Benz® Sprinter are registered trademarks of Daimler AG.

Stanadyne® and PurePower Technologies® are registered trademarks of Stanadyne Corporation.

All other manufacturer names, models, part numbers, and product images used herein are for reference purposes only.





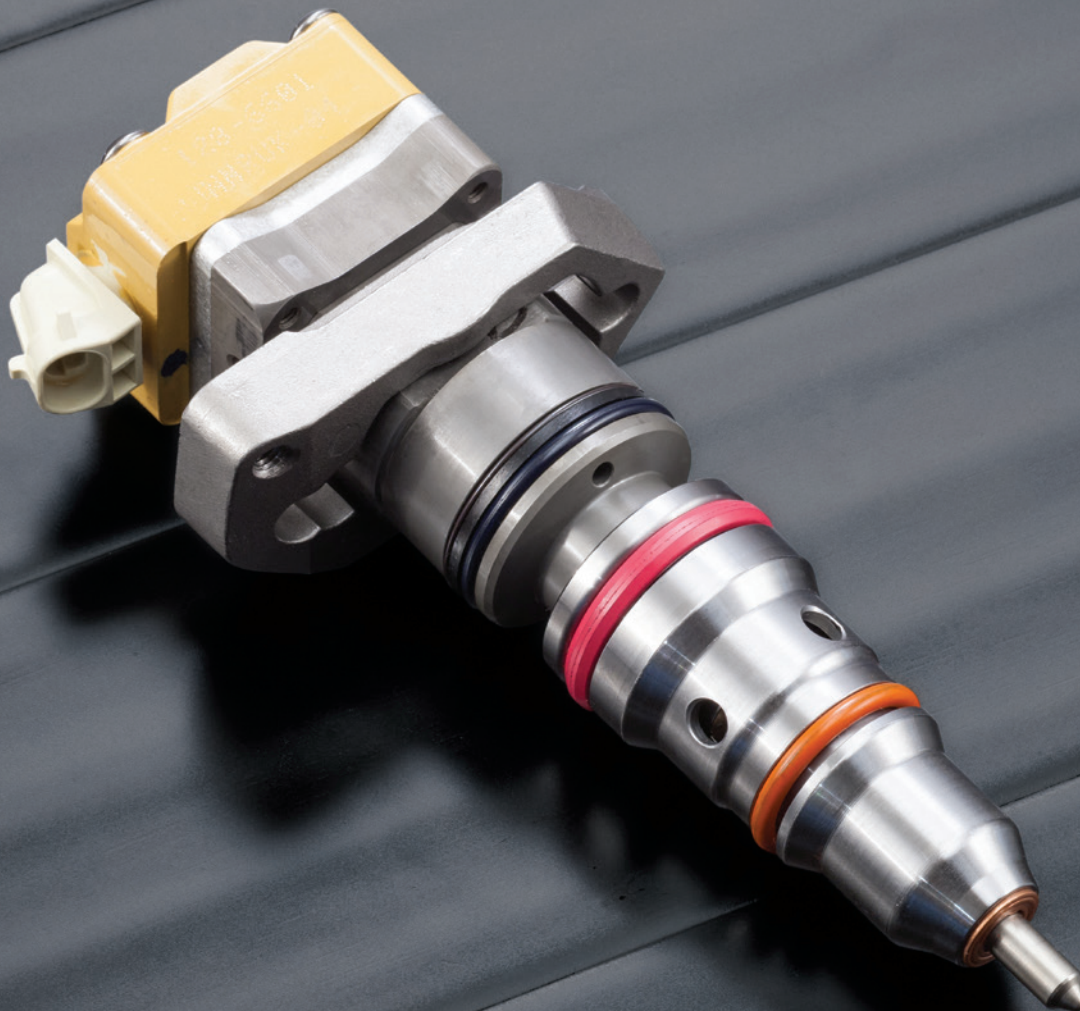

New OEM HEUI® injectors available exclusively through Alliant Power

- Brand new original equipment HEUI injectors
- Complete 1994 to 2003 Ford HD – Pickup and van coverage
- Available exclusively through Alliant Power
- 36-month, unlimited mileage warranty in Ford applications



7.3L POWER STROKE

Injectors

HEUI Injector*

OEM Part Numbers: F81Z9E527DRM, F4TZ9VE527AARM, F7TZ9E527ARM

Year Range:	Application:
1994-1998	F Series
1994-1996	F Series (California)
1994-1996	E Series



AP63800AA

HEUI Injector*

OEM Part Numbers: F81Z9E527BRM, F7TZ9E527BRM, F61Z9VE527BRM, F61Z9VE527L

Notes: Prime (Split Shot) Injector. Engines built BEFORE 12/07/1998.

Year Range:	Application:
1999	F Series
1997-1999	F Series (California)
1997-1998	E Series



AP63801AB

HEUI Injector*

OEM Part Numbers: F81Z9E527CRM, 5C3Z9VE527BRM

Notes: Prime (Split Shot) Injector. Engines built AFTER 12/07/1998.

Year Range:	Application:
1999-2003	F Series, E Series



AP63803AD

HEUI Injector*

OEM Part Numbers: F81Z9E527EARM, XC3Z9E527AARM, 5C3Z9VE527ARM

Notes: Long Lead (LL or blue harness connector) Injector. Engines built AFTER 12/07/1998. Used in #8 cylinder to eliminate "cackle" (Per Ford Bulletins 00-10-1, 00-22-1, and 01-14-6).

Year Range:	Application:	ESN Range:
1999-2003	F Series	661,496 to 896,812
1999-2003	E Series	661,974 to 896,812

AP63804AE

Modules

Glow Plug Control Module (GPCM)

OEM Part Numbers: YC3Z12B533AA, DY876

Notes: Field data indicates Glow Plug Control Modules (GPCMs) were used on 2000 to 2003 vehicles.

Year Range:	Application:
2000-2003	F-250 / F-550, Excursion, E Series



AP63406

*Indicates products with a core charge.

7.3L POWER STROKE

Modules continued

AP65110



Remanufactured Injector Drive Module (IDM)*

OEM Part Numbers: F7T212B599AC, HC2Z12B599BRM

Year Range: 1994½–1998
Application: F Series, E Series

AP65120



Remanufactured Injector Drive Module (IDM)*

OEM Part Numbers: XC3Z12B599AA, 2C2Z12B599A, HC2Z12B599ARM

Year Range: 1999–2003
Application: F Series, Excursion, E Series

Fuel System Components

APM61067

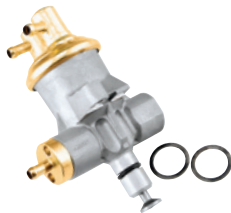

Fuel Transfer Pump–Mechanical

OEM Part Numbers: F6TZ9350A, YC3Z9350CA

Notes: Includes two banjo gaskets.

Year Range: 1994–1998
Application: F Series, E Series

69136



Fuel Transfer Pump–Electronic

OEM Part Numbers: F81Z9C407AC, 0 580 464 074

Year Range: 1993–2003
Application: F Series, Excursion, E Series

AP63409



Fuel Filter Heater Element

OEM Part Number: F5T29J294A

Notes: Field data indicates both elements (AP63409 and AP63410) were used for MY 1998 vehicles. Be sure to verify which element is in place.

Year Range: 1994–1998
Application: F Series, E Series

AP63410



Fuel Filter Heater Element

OEM Part Number: F81Z9J294AA

Notes: Field data indicates both elements (AP63409 and AP63410) were used for MY 1998 vehicles. Be sure to verify which element is in place.

Year Range: 1998–2003
Application: F Series, Excursion, E Series

*Indicates products with a core charge.

7.3L POWER STROKE

Engine Components

Exhaust Back Pressure (EBP) Tube

AP63404

OEM Part Number: 1C3Z9D477AA

Year Range: 1999½-2003
Application: F Series, Excursion, E Series



HEUI Injector Sleeve-Brass

AP63411

OEM Part Number: F4TZ9F538A

Year Range: 1994-2003
Application: F Series, Excursion, E Series



Engine Oil Cooler

AP63452

OEM Part Number: 1C3Z6A642AA

Notes: Requires AP0004 Engine Oil Cooler O-ring and Gasket Kit for installation.

Year Range: 1994-2003
Application: F Series, Excursion, E Series



Water Pump

AP63501

OEM Part Numbers: F81Z8501CRM / ARM, F6TZ8501AARM, 2C3Z8V501BA

Notes: Includes mounting gasket. May require heater hose adapter fitting for installation. See Technical Bulletin APTB 04/06.

Year Range: 1994-1995
Application: F Series, E Series
1996-2003
Application: F Series, Excursion, E Series

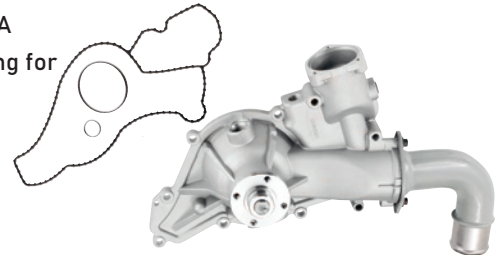

Remanufactured High-Pressure Oil Pump

HP004X

OEM Part Number: F4TZ9A543BRM

Notes: Includes mounting gasket.

Year Range: 1994-1995
Application: F Series, E Series



Remanufactured High-Pressure Oil Pump

HP005X

OEM Part Number: F6TZ9A543ARM

Notes: Includes mounting gasket.

Year Range: 1996-1997
Application: F Series, E Series



7.3L POWER STROKE

Engine Components continued

HP007X



Remanufactured High-Pressure Oil Pump

OEM Part Number: F81Z9A543BRM

Notes: Includes mounting gasket.

Year Range:	Application:
1998-1999½	F Series, E Series

HP008X



Remanufactured High-Pressure Oil Pump

OEM Part Number: F81Z9A543CRM

Notes: Includes mounting gasket.

Year Range:	Application:
1999½-2003	F Series, Excursion, E Series

Sensors

AP63490



Ambient Air Temperature (AAT) Sensor

OEM Part Numbers: 9U2Z12A648A, DY1145

Year Range:	Application:
1994-1998	F Series

AP63491



Camshaft Position (CMP) Sensor

OEM Part Numbers: F4TZ12K073C, DU87

Year Range:	Application:
1994-1996	F Series

AP63400



Camshaft Position (CMP) Sensor

OEM Part Numbers: F7TZ12K073A / B

Year Range:	Application:	ESN Range:
1997-2003	F-250 / F-550	375,549 to 2,030,402
2000-2003	F-650 / F-750	1,026,248 to End
2000-2003	Excursion	896,813 to 2,030,402
1997-2003	E Series	375,549 to 2,030,402

7.3L POWER STROKE

continued **Sensors**

Engine Oil Pressure (EOP) Sensor

OEM Part Numbers: F81Z9278AA, SW5267

Year Range: 1994-2003 Application: F Series, Excursion, E Series

AP63435

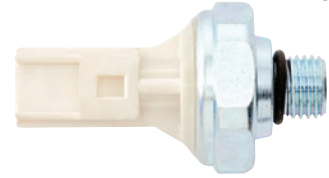

Engine Oil Temperature (EOT) Sensor

OEM Part Numbers: F5AZ12A648AB, 3F1Z12A648A, DY961, DY1144

Year Range: 1994-2003 Application: F Series, Excursion, E Series

AP63436

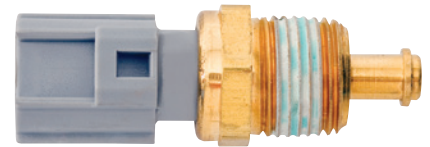

Pressure Sensor

OEM Part Numbers: 1C3Z9J460AA, DPFE1

Notes: Exhaust Back Pressure (EBP).

Year Range: 1994-1997 Application: F Series, E Series

AP63429

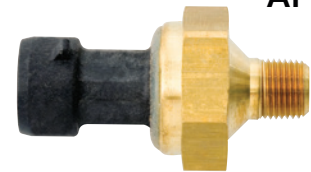

Exhaust Back Pressure (EBP) Sensor

OEM Part Numbers: 4C3Z9J460A, DPFE3

Year Range:	Application:	ESN Range:
1997-2002	F-250 / F-550	501 to 2,030,402
2000-2002	F-650 / F-750	1,026,248 to End
2000-2002	Excursion	896,813 to 2,030,402
1995-2003	E Series	35,651 to 2,030,402

AP63403

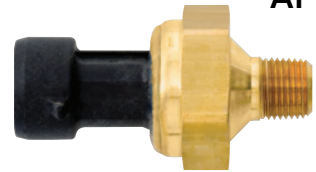

Injection Control Pressure (ICP) Sensor

OEM Part Number: F6TZ9F838A

Year Range:	Application:	ESN Range:
1999-2002	F-250 / F-550	661,974 to 2,030,402
2000-2002	F-650 / F-750	1,026,248 to End
2000-2002	Excursion	896,813 to 2,030,402
1995-2003	E Series	35,651 to 2,030,402

AP63418



Manifold Absolute Pressure (MAP) Sensor

OEM Part Numbers: F4TZ9F479A, DY708

Year Range: 1994-1998 Application: F Series, E Series

AP63489



7.3L POWER STROKE

Sensors continued



Manifold Absolute Pressure (MAP) Sensor

OEM Part Numbers: F8UZ9F479BA, CX1679

Year Range: 1998-2003 Application: F Series, Excursion

Actuators



Injection Pressure Regulator (IPR) Valve

OEM Part Numbers: F4TZ9C968C / CB, 2C3Z9C968BA

Notes: With edge filter.

Year Range: 1994-1995½ Application: F Series, E Series ESN Range: 0 to 187,099



Injection Pressure Regulator (IPR) Valve

OEM Part Numbers: F81Z9C968AA / AB

Notes: Without edge filter.

Year Range: 1995½-2003 Application: F Series, Excursion, E Series ESN Range: 187,100 to End



Glow Plug Relay

OEM Part Numbers: F81Z12B533AC, F7TZ12B533A / CA, DY861, RY525

Year Range: 1994-2003 Application: F-250 / F-550
2000-2002 F-650 / F-750
2000-2002 Excursion
1995-2003 E Series

Electrical Harness and Repair

AP0009 **EXCLUSIVEKITS**

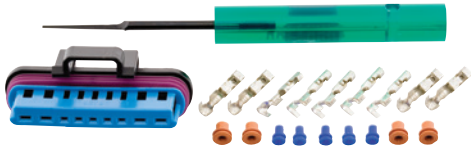

Valve Cover Harness Connector Repair Kit

Notes: Repairs AP0016 Valve Cover Gasket Connector Pigtail.

Year Range: 1998-2003 Application: F Series, Excursion, E Series.

AP0010 **EXCLUSIVEKITS**



Valve Cover Harness Connector Repair Kit

Notes: Repairs AP0015 Valve Cover Gasket Connector Pigtail.

Year Range: 1994-1997 Application: F Series, E Series

7.3L POWER STROKE

continued Electrical Harness and Repair

Valve Cover Gasket Connector Pigtail

Year Range: 1994-1997
Application: F Series, E Series

EXCLUSIVEPARTS AP0015



Valve Cover Gasket Connector Pigtail

Year Range: 1998-2003
Application: F Series, Excursion, E Series

EXCLUSIVEPARTS AP0016

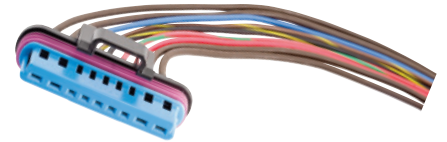

3 Wire Pigtail

OEM Part Number: 5C3Z12224A

Notes: Fits AP63418 Injection Control Pressure (ICP) Sensor as well as AP63403 Exhaust Back Pressure (EBP) Sensor, and AP63429 Pressure Sensor.

Year Range: 1994-2003
Application: F Series, Excursion, E Series

AP0021



2 Wire Pigtail

Notes: Fits AP63401 and AP63402 Injection Pressure Regulator (IPR) Valves and all HEUI A Injectors.

Year Range: 1994-1995½
1995½-2003
Application: F Series, E Series
F Series, Excursion, E Series
ESN Range: 0 to 187,099
187,100 to End

AP0068



Internal Injector Harness

OEM Part Number: F81Z9D930AB

Notes: Use with AP0014 Valve Cover Gasket Kit.

Year Range: 1998-2003
Application: F Series, Excursion, E Series

AP63413

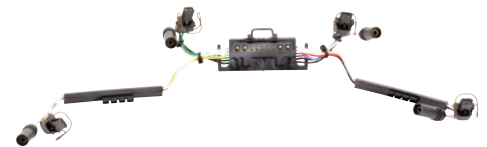

Internal Injector Harness

OEM Part Number: F4TZ9D930K

Notes: Use with AP0013 Valve Cover Gasket Kit.

Year Range: 1994-1997
Application: F Series, E Series

AP63414



7.3L POWER STROKE

Seal and Gasket Kits

AP0001

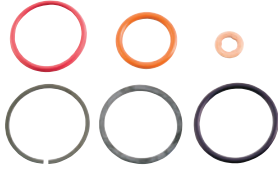

HEUI Injector Seal Kit

OEM Part Numbers: F8TZ9229AA, XC3Z9229AB

Year Range:
1994–2003

Application:
F Series, Excursion, E Series

AP0003

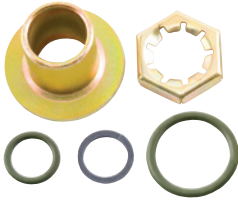

Injection Pressure Regulator (IPR) Valve Seal Kit

OEM Part Numbers: F6TZ9C977AN, 4C3Z9C977AA

Year Range:
1994–2003

Application:
F Series, Excursion, E Series

AP0004

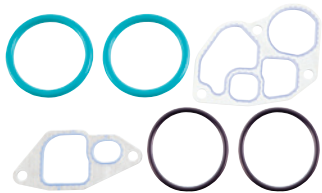

Engine Oil Cooler O-ring and Gasket Kit

OEM Part Numbers: F4TZ6A636A, F7TZ6A636AAA, 1C3Z6C610BA, 1C3Z6K649BA

Year Range:
1994–2003

Application:
F Series, Excursion, E Series

EXCLUSIVEKITS

AP0008

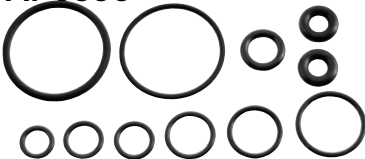

Fuel Filter Drain Valve Kit

OEM Part Numbers: F6TZ9157BA and F5TZ9151A

Year Range:
1994–1997

Application:
F Series, E Series

EXCLUSIVEKITS

AP0007



Fuel Filter Drain Valve Kit

OEM Part Number: F81Z9C065AA

Notes: Includes grommets.

Year Range:
1998–2003

Application:
F Series, Excursion, E Series

AP0011



High-Pressure Oil Pump Seal Kit

OEM Part Number: 2C3Z9G804AB

Year Range:
1994–2003

Application:
F Series, Excursion, E Series

EXCLUSIVEKITS

7.3L POWER STROKE

continued Seal and Gasket Kits

Valve Cover Gasket Kit

OEM Part Number: F4TZ6584A

Notes: Use with AP63414 Internal Injector Harness. Package of two.

Year Range: 1994-1997 Application: F Series, E Series

AP0013

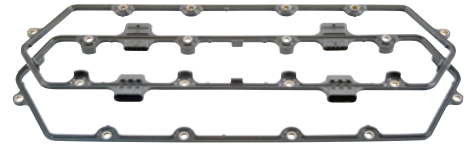

Valve Cover Gasket Kit

OEM Part Number: F81Z6584AA

Notes: Use with AP63413 Internal Injector Harness. Package of two.

Year Range: 1998-2003 Application: F Series, Excursion, E Series

AP0014

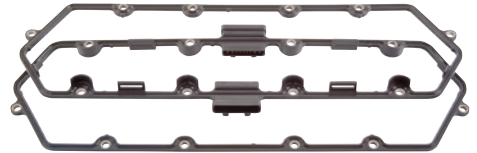

Turbo Installation Kit

OEM Part Number: F81Z6N653BA

Year Range: 1999-2003 Application: F Series, Excursion, E Series

AP63461

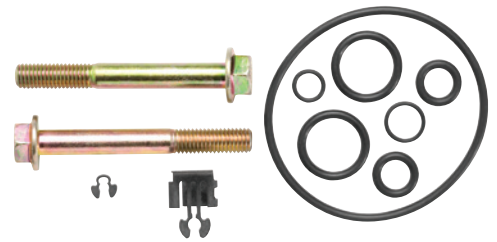

Engine Accessories

Belt Tensioner

OEM Part Numbers: F8UZ6B209CA, BT50

Year Range: 1998-2003 Application: F Series, E Series
2000-2003 Excursion

AP63421



Vacuum Pump-Electronic

OEM Part Numbers: 6C3Z2A451A, 6C3A2A451BA, F81Z2A451BA, 4C3Z2A451BA, BRPV-7

Year Range: 1998-2003 Application: F Series, Excursion, E Series

AP63433



7.3L POWER STROKE

Engine Accessories continued

AP63700



Vacuum Pump–Mechanical

OEM Part Numbers: F6TZ2A451AA, BRPV-6

Year Range:	Application:
1998–2002	F–250 / F–450
2000–2002	F–550
1996–2002	E–350
2002	E–450 / E–550

AP63724



Vacuum Pump–Mechanical

OEM Part Numbers: F4TZ2A451A, BRPV-5

Year Range:	Application:
1994–1998	F Series, E Series

Filters

PFF829B



Spin-on Fuel Filter/Water Separator

OEM Part Number: FD3375

Notes: Only fits 7.3L IDI Diesel.

Year Range:	Application:
1988–1994	F Series, E Series

PFRK20567

RACOR



Fuel Filter Bowl/Drain Assembly

Notes: Use with PFF829B Spin-on Fuel Filter/Water Separator. Only fits 7.3L IDI Diesel.

Year Range:	Application:
1988–1994	F Series, E Series

PFF4595
RACOR



Fuel Filter Element Service Kit

OEM Part Number: FD4495

Year Range:	Application:
1994–1999	F Series, E Series

7.3L POWER STROKE

continued Filters

Fuel Filter Top Cover

OEM Part Number: F5TZ9G270A

Year Range: 1994-1998 Application: F Series, E Series

RACOR.



RK31019

Fuel Filter Element Service Kit

OEM Part Number: FD4596

Year Range: 1999-2003 Application: F Series, Excursion, E Series

RACOR.



PFF4596

Fuel Filter Top Cover

Year Range: 1998½-2003 Application: F Series, Excursion, E Series

RACOR.



RK31449

Fuel Filter Housing Assembly

OEM Part Numbers: F6TZ9155AB, FG1054

Notes: Includes PFF4595 Fuel Filter Element Service Kit, RK31019 Fuel Filter Top Cover, and AP63409 Fuel Filter Heater Element. Field data indicates both housings (AP63424 and AP63425) were used for MY 1998 vehicles. Be sure to verify which housing is in place.

Year Range: 1994-1998 Application: F Series

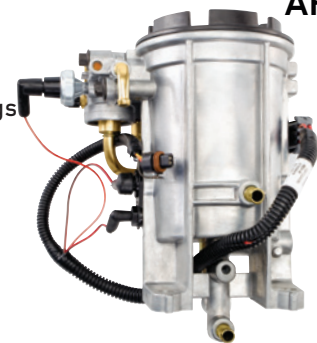

AP63424

Fuel Filter Housing Assembly

OEM Part Numbers: F81Z9155AC, FG1057

Notes: Includes PFF4596 Fuel Filter Element Service Kit, RK31449 Fuel Filter Top Cover, and AP63410 Fuel Filter Heater Element. Field data indicates both housings (AP63424 and AP63425) were used for MY 1998 vehicles. Be sure to verify which housing is in place.

Year Range: 1998½-2003 Application: F Series, Excursion, E Series



AP63425



NEW

Injector Coils



NEW

Connector



NEW

Spool Valve

Alliant Power partners with PurePower Technologies®!

PurePower's industry leading remanufactured G2.8 injectors now available to the aftermarket through Alliant Power.

Remanufactured by PurePower Technologies:

- 100% new coil and harness assemblies with vented slot technology
- · 100% new spool valve and connector
- 24-month, unlimited mileage warranty in Ford applications



6.0L & 4.5L POWER STROKE

Injectors

PPT Remanufactured G2.8 Injector* PPT New G2.8 njector*

OEM Part Numbers: 3C3Z9E527EBRM / EARM / AE / ABRM / ECRM, 6901-PP, 6918-PP

Notes: Engines built BEFORE 09/22/2003.

Year Range:	Application:	ESN Range:
2003-09/21/2003	F-250 / F-550, Excursion	0 to 137,745 (Alabama built)
2003-09/21/2003	F-250 / F-550, Excursion	6,000,000 to 6,155,636 (Indiana built)
2003-09/21/2003	F-650 / F-750	0 to 112,360 (Alabama built)

AP60900
AP60800



AP60901
AP60801

PPT Remanufactured G2.8 Injector* PPT New G2.8 Injector*

OEM Part Numbers: 4C3Z9E527AA / BRM, 7E7Z9E527AA, 6902-PP, 6919-PP

Notes: Engines built ON or AFTER 09/22/2003.

Year Range:	Application:
09/22/2003-2007	F-250 / F-550, Excursion
2005-2007	F-650 / F-750
2004-2010	E Series
2006-2010	4.5L LCF



Modules

Glow Plug Control Module (GPCM)

OEM Part Numbers: YC3Z12B533AA, DY876

Year Range:	Application:
2003-2007	F-250 / F-550, Excursion
2004-2010	E Series

AP63406

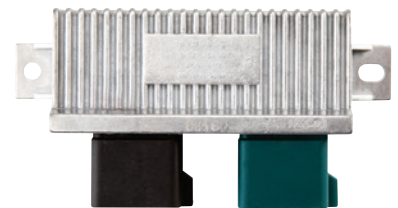

*Indicates products with a core charge.

6.0L & 4.5L POWER STROKE

Modules continued

AP65122



Remanufactured Fuel Injection Control Module (FICM)*

OEM Part Numbers: 4C3Z12B599ABRM / AB / CRM / AARM

Notes: Pre-programmed. Engines built BEFORE 09/22/2003.

Year Range: 2003-09/21/2003 Application: F-250 / F-550, Excursion

AP65123



Remanufactured Fuel Injection Control Module (FICM)*

OEM Part Numbers: 4C3Z12B599ABRM / AB / DRM

Notes: Pre-programmed. Engines built ON or AFTER 09/22/2003.

Year Range: 09/22/2003-2004 Application: F-250 / F-550
09/22/2003-01/31/2005 Excursion

AP65124



Remanufactured Fuel Injection Control Module (FICM)*

OEM Part Numbers: 4C3Z12B599ABRM / AB / ERM

Notes: Pre-programmed.

Year Range: 2005-2007 Application: F-250 / F-550
02/01/2005-2005 Excursion
2004-2010 E Series

Engine Components

AP63445 **EXCLUSIVEKITS**

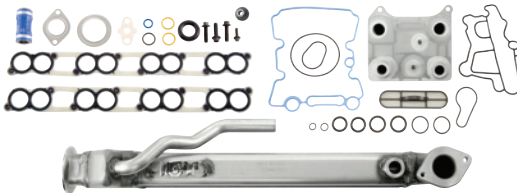

Oil Cooler/Exhaust Gas Recirculation (EGR) Cooler Kit*

Notes: Includes AP63451 Engine Oil Cooler Kit and AP63446 Exhaust Gas Recirculation (EGR) Cooler Kit. Core required only on the Exhaust Gas Recirculation (EGR) Cooler.

Year Range: 2004-2007 Application: F Series, Excursion
2004-2010 E Series

AP63446 **EXCLUSIVEKITS**



Exhaust Gas Recirculation (EGR) Cooler Kit*

OEM Part Numbers: 4C3Z9P456AF / AC / AH / AJ

Notes: Includes AP63447 Exhaust Gas Recirculation (EGR) Cooler Intake Gasket Kit.

Year Range: 2004-2007 Application: F Series, Excursion
2004-2010 E Series

AP63451

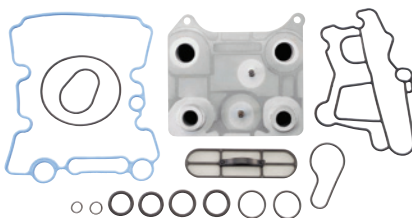

Engine Oil Cooler Kit

OEM Part Number: 3C3Z6A642CA

Notes: Includes AP0039 Engine Oil Cooler Gasket Kit.

Year Range: 2003-2007 Application: F Series, Excursion
2004-2010 E Series
2006-2010 4.5L LCF

6.0L & 4.5L POWER STROKE

continued Engine Components

Turbo Hose-Short

OEM Part Numbers: 6C3Z6C640C / CA
 Year Range: 2003-2004
 Application: F Series, Excursion

AP63454

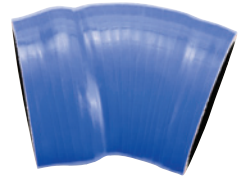

Turbo Hose-Long

OEM Part Numbers: 6C3Z6C640A / AA
 Year Range: 2004½-2007
 Application: F Series, Excursion

AP63455



Thermostat

OEM Part Numbers: 3C3Z8575AA, RT1169
 Year Range: 2003-2007
 Application: F Series, E Series

AP63496

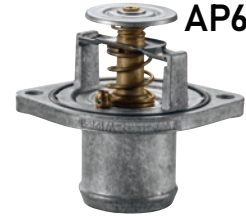

Water Pump

OEM Part Numbers: 3C3Z8501A, PW480
 Notes: Includes mounting gasket. F-650 / F-750 use AP63583 Water Pump Navistar VT365.
 Year Range: 2003-07/19/2004
 Application: F-250 / F-550, Excursion
 2004-07/19/2004 E Series

AP63502



Water Pump

OEM Part Numbers: 4C3Z8501AC, PW491
 Notes: Includes mounting gasket. F-650 / F-750 use AP63583 Water Pump Navistar VT365.
 Year Range: 07/20/2004-2007
 Application: F-250 / F-550, Excursion
 07/20/2004-2010 E Series
 2006-2010 4.5L LCF

AP63503

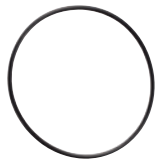

Remanufactured High-Pressure Oil Pump*

OEM Part Numbers: 5C4Z9A543A / B, 5C3Z9A543C / ARM
 Notes: Includes seal kit.

Year Range: 2004½-2007
 Application: F Series, Excursion
 2004½-2010 E Series

AP63661

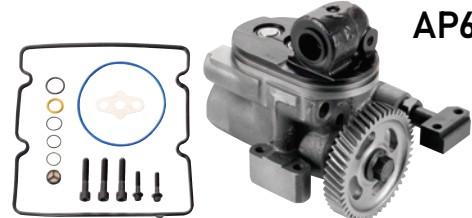

*Indicates products with a core charge.

6.0L & 4.5L POWER STROKE

Engine Components continued

AP63662

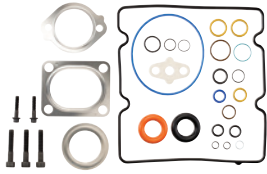

Remanufactured High-Pressure Oil Pump*

OEM Part Number: 6E7Z9A543BRM

Notes: Includes seal kit.

Year Range: 2006-2007 Application: 4.5L LCF

AP63663

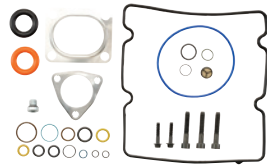

Remanufactured High-Pressure Oil Pump*

OEM Part Number: 8E7Z9A543CRM

Notes: Includes seal kit.

Year Range: 2008-2010 Application: 4.5L LCF

HP032X



Remanufactured High-Pressure Oil Pump

OEM Part Numbers: 3C3Z9A543AARM, 4C3Z9A543AARM

Notes: Includes seal kit.

Year Range: 2003-2004 Application: F Series, Excursion, E Series



BOLINGBROOK, IL 815.886.9900	PALATINE, IL 847.991.7867	PERU, IL 815.224.3439	CHICAGO, IL 773.475.9000	ROCKDALE, IL 815.744.7800	AGAWAM, MA 413.789.6600	ALLENTOWN, PA 610.395.3718
DEEP RIVER, CT 860.526.5941	PORTLAND, OR 503.283.5615	ALBANY, OR 541.248.3802	BOCA RATON, FL 561.241.0242	CONCORD, NC 704.721.6661	WASHINGTON, DC 708.514.2016	VISIT US ONLINE: SeidelDiesel Group.com

*Indicates products with a core charge.

6.0L & 4.5L POWER STROKE

Sensors

Engine Speed/Position Sensor

OEM Part Numbers: 3C3Z6C315AA, DY985

Notes: Crankshaft Speed/Position.

Year Range:	Application:
2003-2007	F Series, Excursion
2004-2010	E Series
2006-2010	4.5L LCF



AP63412

Engine Speed/Position Sensor

OEM Part Numbers: 3C3Z12K073AA, 8C3Z12K073A, DU88

Notes: Camshaft Speed/Position.

Year Range:	Application:
2003-2007	F Series, Excursion
2004-2010	E Series
2006-2010	4.5L LCF



AP63415

Ambient Air Temperature (AAT) Sensor

OEM Part Numbers: AE5Z12A647A, DY1137

Year Range:	Application:
2004½-2008	F Series
2006-2008	E Series



AP63493

Engine Oil Pressure (EOP) Sensor

OEM Part Numbers: F81Z9278AA, SW5267

Year Range:	Application:
2003-2007	F Series, Excursion
2004-2010	E Series
2006-2010	4.5L LCF

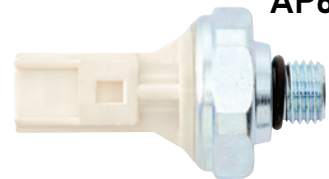

AP63435

Engine Oil/Coolant/Fuel Temperature (EOT/ECT/FT) Sensor

OEM Part Numbers: 3C3Z10884AA, SW6052

Year Range:	Application:
2003-2007	F Series, Excursion
2004-2010	E Series
2006-2010	4.5L LCF

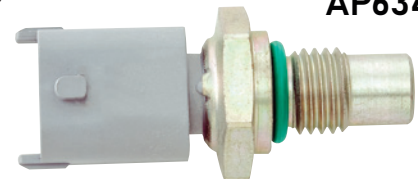

AP63437

Exhaust Back Pressure (EBP) Sensor

OEM Part Numbers: 4C3Z9J460A, DPFE3

Year Range:	Application:	ESN Range:
2003-2004	F Series, Excursion	6,000,000 to 6,344,942
2004	E Series	0 to 149,760

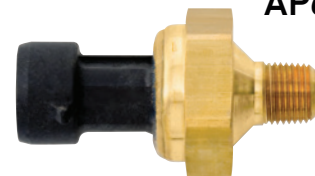

AP63403

6.0L & 4.5L POWER STROKE

Sensors continued

AP63408

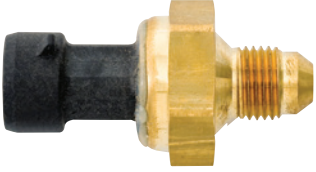

Exhaust Back Pressure (EBP) Sensor

OEM Part Numbers: 5C3Z9J460A / B, DPFE6

Year Range:	Application:	ESN Range:
2005-2007	F-250 / F-550, Excursion	6,344,943 to
End		
2003-2007	F-650 / F-750	
2004-2010	E Series	149,761 to End

AP63407



Injection Control Pressure (ICP) Sensor

OEM Part Number: 3C3Z9F838EA

Notes: Mounts below turbo.

Year Range:	Application:
2003-2004	F Series, Excursion

AP63460

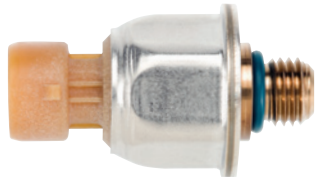

Injection Control Pressure (ICP) Sensor

OEM Part Numbers: 4C3Z9F838A / AB

Notes: Mounts on passenger side valve cover.

Year Range:	Application:
2004-2007	F Series, Excursion
2004-2010	E Series
2006-2010	4.5L LCF

AP63462

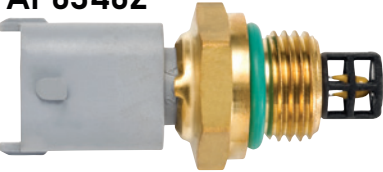

Intake Manifold Air Temperature (IAT) Sensor

OEM Part Numbers: 3C3Z12A697AA, DY984

Year Range:	Application:
2003-2010	F Series, Excursion, E Series
2006	4.5L LCF

AP63463



Intake Manifold Air Temperature (IAT) Sensor

OEM Part Numbers: 8C3Z12A697B, DY1112

Year Range:	Application:
2007-2010	4.5L LCF

AP63495



Manifold Absolute Pressure (MAP) Sensor

OEM Part Numbers: 2L1Z9F479AA, CX1961

Year Range:	Application:
2003-2007	F Series
2003-2005	Excursion
2003-2010	E Series

6.0L & 4.5L POWER STROKE

continued **Sensors**

Mass Air Flow (MAF) Sensor*

OEM Part Numbers: 3L3Z12B579ARM, AFLS181RM

Year Range: 2003-2007 Application: F Series, Excursion



Transmission Fluid Temperature Sensor

OEM Part Number: 3C3Z7H141AA

Year Range: 2003-2007 Application: F Series
2004-2010 E Series



Actuators

Injection Pressure Regulator (IPR) Valve

OEM Part Numbers: 3C3Z9C968AA, CM5054

Notes: Without edge filter.

Year Range: 2003-2004 Application: F Series, Excursion

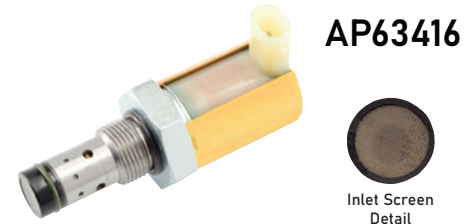

Injection Pressure Regulator (IPR) Valve

OEM Part Numbers: 5C3Z9C968CA, CM5126

Notes: With edge filter.

Year Range: 2005-2007 Application: F Series, Excursion
2004-2010 E Series
2006-2010 4.5L LCF

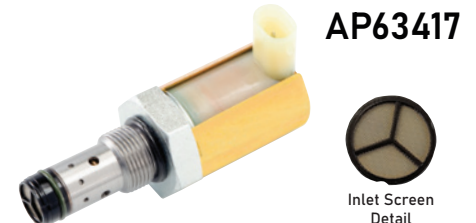

Remanufactured Exhaust Gas Recirculation (EGR) Valve*

OEM Part Numbers: 4C3Z9F452A / ARM, CX2056, CX2467RM

Year Range: 2003-2004 Application: F Series, Excursion

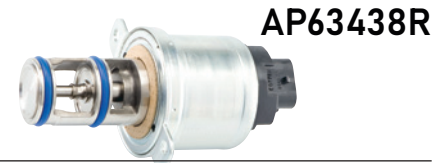

Remanufactured Exhaust Gas Recirculation (EGR) Valve*

OEM Part Numbers: 5C3Z9F452AA / ARM, CX2020, CX2466RM

Year Range: 2004½-2007 Application: F-250 / F-550, Excursion
2004½-2010 E Series



Turbocharger Vane Actuator

OEM Part Numbers: 5C3Z6F089A / BA, 792593-0001

Year Range: 2003-2007 Application: F Series, Excursion
2004-2010 E Series



*Indicates products with a core charge.

6.0L & 4.5L POWER STROKE

Electrical Harness and Repair

AP0021



3 Wire Pigtail

OEM Part Number: 5C3Z12224A

Notes: Fits AP63407 and AP63460 Injection Control Pressure (ICP) Sensors as well as AP63403 and AP63408 Exhaust Back Pressure (EBP) Sensors.

Year Range:	Application:
2003-2007	F Series, Excursion
2004-2010	E Series
2006-2010	4.5L LCF

AP0056



2 Wire Pigtail

Notes: Fits AP63437 Engine Oil/Coolant/Fuel Temperature (EOT/ECT/FT) Sensor and AP63462 Intake Manifold Air Temperature (IAT) Sensor.

Year Range:	Application:
2003-2007	F Series, Excursion
2004-2010	E Series
2006-2010	4.5L LCF

AP0030



NEXCLUSIVEPARTS

Injector Harness Connector

Year Range:	Application:
2003-2007	F Series, Excursion
2004-2010	E Series
2006-2010	4.5L LCF

AP0040



NEXCLUSIVEPARTS

G2.8 Injector Connector

Notes: See Technical Bulletin APTB 03/14 for installation instructions.

Year Range:	Application:
2003-2007	F Series, Excursion
2004-2010	E Series
2006-2010	4.5L LCF

AP0018

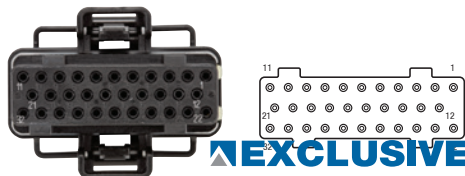

NEXCLUSIVEPARTS

Fuel Injection Control Module (FICM) Connector

Notes: Field data shows identification marks 1456315-6, 1437287-7, or X-3.

Year Range:	Application:
2003-2007	F Series, Excursion
2004-2010	E Series
2006-2010	4.5L LCF

AP0019



NEXCLUSIVEPARTS

Fuel Injection Control Module (FICM) Connector

Notes: Field data shows identification marks 1456315-2, 1437287-6, or X-2.

Year Range:	Application:
2003-2007	F Series, Excursion
2004-2010	E Series
2006-2010	4.5L LCF

6.0L & 4.5L POWER STROKE

continued Electrical Harness and Repair

Fuel Injection Control Module (FICM) Connector

Notes: Field data shows identification marks 1456316-1, 1437287-5, or X-1.

Year Range:	Application:
2003-2007	F Series, Excursion
2004-2010	E Series
2006-2010	4.5L LCF



AP0020

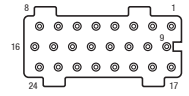

Fuel Injection Control Module (FICM) Connector Pigtail

Notes: Replaces AP0018 Fuel Injection Control Module (FICM) Connector. Field data shows identification marks 1456315-6, 1437287-7, or X-3.

Year Range:	Application:
2003-2007	F Series, Excursion
2004-2010	E Series



AP0031

Fuel Injection Control Module (FICM) Connector Pigtail

Notes: Replaces AP0019 Fuel Injection Control Module (FICM) Connector. Field data shows identification marks 1456315-2, 1437287-6, or X-2.

Year Range:	Application:
2003-2007	F Series, Excursion
2004-2010	E Series



AP0032

Fuel Injection Control Module (FICM) Connector Pigtail

Notes: Replaces AP0020 Fuel Injection Control Module (FICM) Connector. Field data shows identification marks 1456316-1, 1437287-5, or X-1.

Year Range:	Application:
2003-2007	F Series, Excursion
2004-2010	E Series



AP0033

2 Wire Pigtail

Notes: Fits AP63416 and AP63417 Injection Pressure Regulator (IPR) Valves and AP91000 Turbocharger Vane Actuator.

Year Range:	Application:
2003-2007	F Series, Excursion
2004-2010	E Series
2006-2010	4.5L LCF



AP0068



6.0L & 4.5L POWER STROKE

Seal and Gasket Kits

AP0002 **EXCLUSIVEKITS**



G2.8 Injector Seal Kit

OEM Part Numbers: 3C3Z9229AA, CM5055

Notes: Includes high-pressure oil seal.

Year Range:	Application:
2003-2007	F Series, Excursion
2004-2010	E Series
2006-2010	4.5L LCF

AP0005



Exhaust Gas Recirculation (EGR) Valve O-ring Kit

OEM Part Number: 3C3Z9P455AB

Year Range:	Application:
2003-2007	F Series, Excursion
2004-2010	E Series

AP0023

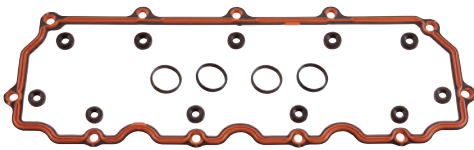

Valve Cover Gasket

OEM Part Number: 3C3Z6584BA

Year Range:	Application:
2003-2007	F Series, Excursion
2004-2010	E Series

AP0028 **EXCLUSIVEKITS**



Stand Pipe and Front Port Plug Seal Kit

OEM Part Numbers: W302209, W301386, and W301390

Notes: Reseals one side.

Year Range:	Application:
2003-2007	F Series, Excursion
2004-2010	E Series
2006-2010	4.5L LCF

AP0035



Injection Pressure Regulator (IPR) Valve Seal Kit

OEM Part Number: 3C3Z9H529A

Year Range:	Application:
2003-2007	F Series, Excursion
2004-2010	E Series
2006-2010	4.5L LCF

AP0039

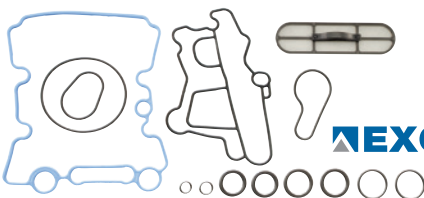

Engine Oil Cooler Gasket Kit

Year Range:	Application:
2003-2007	F Series, Excursion
2004-2010	E Series
2006-2010	4.5L LCF

EXCLUSIVEKITS

6.0L & 4.5L POWER STROKE

continued Seal and Gasket Kits

Head Gasket Kit with Studs** Head Gasket Kit without Studs

Notes: 18 mm dowels.

Year Range: 2003-2006
2004-2006

Application: F Series, Excursion
E Series

Kit Contents:

- 2 Cylinder Head Gaskets with 18 mm Dowels
- 2 Exhaust Manifold Gaskets
- 2 Rocker Housing Gaskets
- 1 Secondary Fuel Filter Seal Kit
- 4 Fuel Inlet Copper Washers
- 2 Valve Cover Gaskets
- 8 Injector Seal Kits
- 1 Exhaust Gas Recirculation (EGR) Cooler Intake Gasket Kit
- 1 Exhaust Gas Recirculation (EGR) Valve O-ring Kit
- 2 Stand Pipe and Front Port Plug Seal Kits
- ** Includes Head Stud Kit



EXCLUSIVE KITS AP0043 AP0060

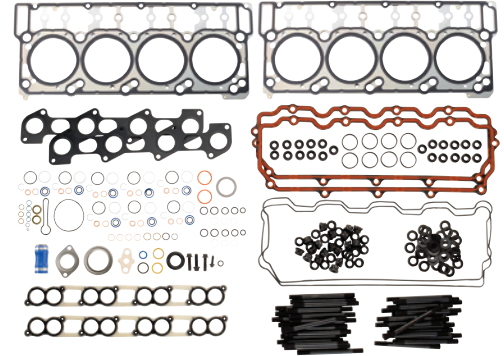

Head Gasket Kit with Studs** Head Gasket Kit without Studs

Notes: 20 mm dowels.

Year Range: 2006-2007
2006-2010

Application: F Series, Excursion
E Series

Kit Contents:

- 2 Cylinder Head Gaskets with 20 mm Dowels
- 2 Exhaust Manifold Gaskets
- 2 Rocker Housing Gaskets
- 1 Secondary Fuel Filter Seal Kit
- 4 Fuel Inlet Copper Washers
- 2 Valve Cover Gaskets
- 8 Injector Seal Kits
- 1 Exhaust Gas Recirculation (EGR) Cooler Intake Gasket Kit
- 1 Exhaust Gas Recirculation (EGR) Valve O-ring Kit
- 2 Stand Pipe and Front Port Plug Seal Kits
- **Includes Head Stud Kit



EXCLUSIVE KITS AP0044 AP0061

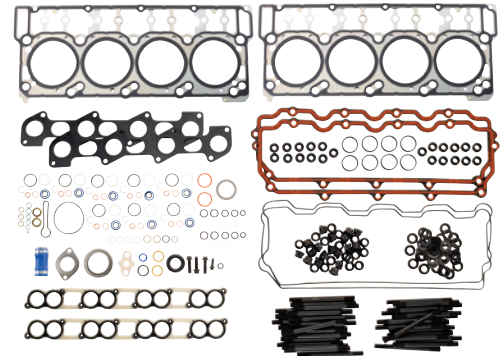

High-Pressure Oil Rail Seal Kit

Notes: AP0069 High-Pressure Oil Rail Socket required for installation.

Year Range: 2003-2007
2004-2010
2006-2010

Application: F Series, Excursion
E Series
4.5L LCF

EXCLUSIVE KITS AP0070



Fuel Pressure Regulator Kit

OEM Part Number: 3C3Z9T517AG

Year Range: 2003-2007
2004-2010

Application: F Series
E Series

AP0086

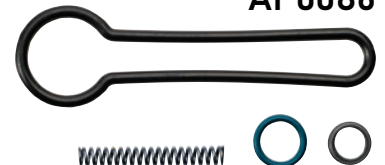

6.0L & 4.5L POWER STROKE

Seal and Gasket Kits continued

AP0098

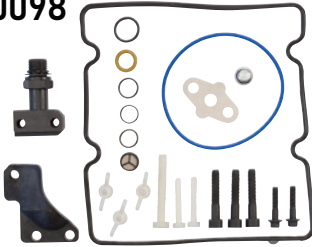

High-Pressure Oil Pump (HPOP) Installation Kit with Fitting

Notes: Includes updated outlet fitting.

Year Range:
2004½-2007
2004½-2010

Application:
F Series, Excursion
E Series

AP0099

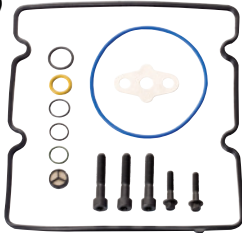

High-Pressure Oil Pump (HPOP) Installation Kit without Fitting

Year Range:
2004½-2007
2004½-2010

Application:
F Series, Excursion
E Series

AP63447

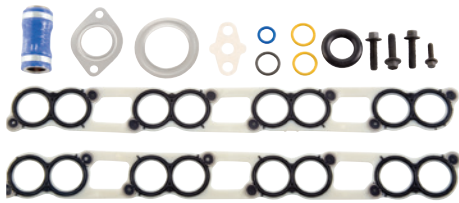

Exhaust Gas Recirculation (EGR) Cooler Intake Gasket Kit

OEM Part Numbers: 3C3Z9433BE / BH

Year Range:
2003-2007
2004-2010

Application:
F Series, Excursion
E Series

EXCLUSIVEKITS

AP63481



Turbo Installation Kit

OEM Part Number: 3C3Z9T514AG

Year Range:
2004-2007
2004-2010

Application:
F Series, Excursion
E Series

Engine Accessories

AP63430



Fan Clutch

OEM Part Numbers: 4C3Z8A616AA, YB632

Year Range:
2003-2007
2004-2010

Application:
F-250 / F-550, Excursion
E Series

AP63432



Belt Tensioner

OEM Part Number: 3C2Z6B209BA

Notes: Dual alternator configurations.

Year Range:
2003-2007
2004-2010

Application:
F-250 / F-550, Excursion
E Series

6.0L & 4.5L POWER STROKE

continued Engine Accessories

Belt Tensioner

OEM Part Number: 3C2Z6B209AA

Year Range: 2003-2007
2004-2010

Application: F-250 / F-550, Excursion
E Series



AP63448

Vacuum Pump-Electronic

OEM Part Numbers: 6C3Z2A451A, 6C3A2A451BA, F81Z2A451BA, 4C3Z2A451BA, BRPV-7

Year Range: 2003-2007

Application: F-250 / F-550, Excursion



AP63433

Vacuum Pump-Mechanical

OEM Part Numbers: 4C2Z2A451AA, AC2Z2A451A, BRPV-1 / 11

Year Range: 2004-2010

Application: E Series



AP63703

Starter

OEM Part Numbers: 3C3Z11002AA, 3C3U11000AB, 6C2Z11002AA

Year Range: 2003-2007
2004-2010

Application: F-250 / F-550, Excursion
E Series



AP83006

Filters

Horizontal Fuel Conditioning Module (HFCM)

OEM Part Numbers: 3C3Z9C407AB, 6C3Z9C407AA, 6C3Z9G282AA, PFB93, PFB101

Notes: Field data indicates that some vehicles built BEFORE 09/15/2003 may have three plug connections and would require a new wiring harness (6C3Z9F759A) for installation.

Year Range: 2003-2007

Application: F-250 / F-550

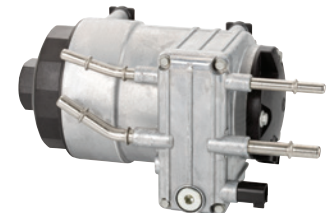

AP63426

Vertical Fuel Conditioning Module (VFCM)

OEM Part Numbers: 6C2Z9G282AA, PFB98, 9C2Z9G282A, 6C3Z9G282C

Year Range: 2004-2010

Application: E Series



AP63431

6.0L & 4.5L POWER STROKE

Filters continued

PFP58565

RACOR



Replacement Fuel Pump

OEM Part Number: 6E7Z9350D

Notes: Does not include housing.

Year Range:	Application:
2006-2010	4.5L LCF

PFF31795



RACOR

Fuel Filter Housing Cap

OEM Part Number: 3C3Z9G270AA

Year Range:	Application:
2003-2007	F-250 / F-550, Excursion
2004-2010	E Series
2006-2010	4.5L LCF

PFF4606



RACOR

Fuel Filter Element Service Kit

OEM Part Number: FD4606

Notes: Primary and secondary.

Year Range:	Application:
2004-2010	E Series

RK58052



RACOR

Replacement Plastic Bowl Assembly with Drain and WIF Sensor

OEM Part Number: 4C2Z9A343AA

Notes: Use with PFF4606 Fuel Filter Element Service Kit.

Year Range:	Application:
2004-2010	E Series

PFF4616



RACOR

Fuel Filter Element Service Kit

OEM Part Number: FD4604

Notes: Primary and secondary.

Year Range:	Application:
2003-2007	F-250 / F-550, Excursion
2006-2010	4.5L LCF

PFL2016



RACOR

Oil Filter Element Service Kit

OEM Part Number: FL2016

Year Range:	Application:
2003-2007	F Series, Excursion
2004-2010	E Series

6.0L & 4.5L POWER STROKE

continued **Filters**

Oil Filter Cap

OEM Part Number: 3C3Z6766CA

Year Range: 2003-2007
2006-2010

Application: F Series, Excursion
4.5L LCF

RK31821



Oil Filter Cap

OEM Part Number: 4C2Z6766BA

Year Range: 2004-2010

Application: E Series

RK32138



Replacement Fuel Pump

OEM Part Number: 6C3Z9C407AA

Notes: Does not include housing.

Year Range: 2003-2007
2004-2010

Application: F-250 / F-550
E Series

PFP58054



**Click to Explore
Mid-Range &
Heavy-Duty
Application Guide**





Alliant Power partners with PurePower Technologies®!

PurePower's industry leading remanufactured piezo injectors now available to the aftermarket through Alliant Power.

- Remanufactured by PurePower Technologies
 - Piezos are 100% tested for performance and replaced with new when necessary
- 24-month, unlimited mileage warranty in Ford applications
- Brand new injectors also available



6.4L POWER STROKE

Injectors

PPT Remanufactured Piezo Injector*
PPT New Piezo Injector*

OEM Part Numbers: 8C3Z9E527A / DRM, 6903-PP, 6920-PP

Notes: Includes injection line.

Year Range: 2008-2010 Application: F-250 / F-550

AP64900
AP64800



Modules

Glow Plug Control Module (GPCM)

OEM Part Numbers: YC3Z12B533AA, DY876

Year Range: 2008-2010 Application: F-250 / F-550

AP63406



Engine Components

Coolant Pump

OEM Part Number: 7C3Z8B552A

Year Range: 2008-2010 Application: F-250 / F-550

AP63472



Exhaust Back Pressure (EBP) Tube

OEM Part Number: 8C3Z9F459A

Year Range: 2008-2010 Application: F-250 / F-550

AP63520



*Indicates products with a core charge.

6.4L POWER STROKE

Engine Components continued

AP63498



Thermostat Kit

OEM Part Numbers: 8C3Z8575D, RT1212

Year Range: 2008-2010 Application: F-250 / F-550

AP63504

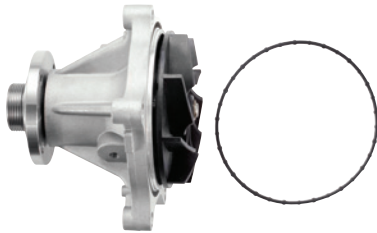

Water Pump

OEM Part Numbers: 8C3Z8501B, PW482

Notes: Includes mounting gasket.

Year Range: 2008-2010 Application: F-250 / F-550

AP63468

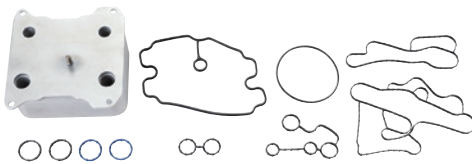

Engine Oil Cooler Kit

OEM Part Number: 8C3Z6A642A

Notes: Includes engine oil cooler and installation kit.

Year Range: 2008-2010 Application: F-250 / F-550

AP63643

EXCLUSIVE KITS

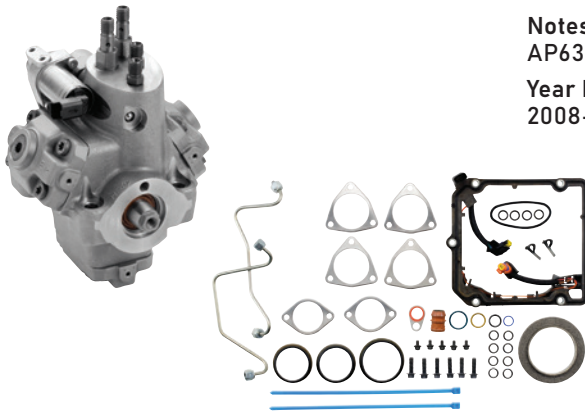

Remanufactured High-Pressure Fuel Pump (HPFP) Kit*

OEM Part Numbers: 8C3Z9A543DRM / B

Notes: Includes pump and installation kit. If pump only is needed see AP63645 Remanufactured High-Pressure Fuel Pump (HPFP).

Year Range: 2008-2010 Application: F-250 / F-550

AP63645



Remanufactured High-Pressure Fuel Pump (HPFP)*

OEM Part Numbers: 8C3Z9A543DRM / B

Notes: Includes pump only. If installation kit is needed see AP0071 High-Pressure Fuel Pump (HPFP) Installation Kit. If pump and installation kit are needed see AP63643 Remanufactured High-Pressure Fuel Pump (HPFP) Kit.

Year Range: 2008-2010 Application: F-250 / F-550

*Indicates products with a core charge.

6.4L POWER STROKE

Exhaust Aftertreatment

Diesel Particulate Filter (DPF)

AP70000

OEM Part Number: 9C3Z5H221B

Notes: Includes installation kit. Pickup truck (wide frame). Not available for sale or use in California.

Year Range: 2008-2010 Application: F-250 / F-450



AP70001

Diesel Particulate Filter (DPF)

OEM Part Number: 9C3Z5H221A

Notes: Includes installation kit. Chassis cab (narrow frame). Not available for sale or use in California.

Year Range: 2008-2010 Application: F-350 / F-550

EXCLUSIVEKITS

Diesel Particulate Filter Pressure (DPFP) Sensor Fitting

AP0164

OEM Part Number: 7C3Z9J454A

Notes: Alliant Power has found this fitting to break while changing the DPFP sensor in the DPF.

Year Range: 2008-2010 Application: F-250 / F-550



Sensors

Engine Speed/Position Sensor

AP63412

OEM Part Numbers: 3C3Z6C315AA, DY985

Notes: Crankshaft Speed/Position.

Year Range: 2008-2010 Application: F Series



Engine Speed/Position Sensor

AP63415

OEM Part Numbers: 3C3Z12K073AA, 8C3Z12K073A, DU88

Notes: Camshaft Speed/Position.

Year Range: 2008-2010 Application: F Series



Ambient Air Temperature (AAT) Sensor

AP63493

OEM Part Numbers: AE5Z12A647A, DY1137

Year Range: 2008-2010 Application: F-250 / F-550



6.4L POWER STROKE

Sensors continued

AP63422

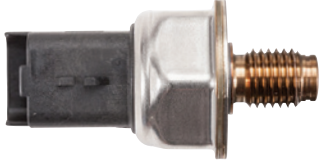

Fuel Rail Pressure Sensor

OEM Part Number: 8C3Z9G756A

Year Range: 2008-2010 Application: F Series

AP63423

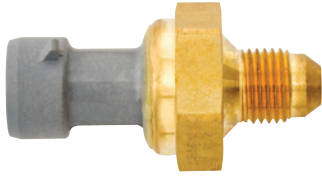

Exhaust Back Pressure (EBP) Sensor

OEM Part Numbers: 7E7Z9J460AA, 8C3Z9J460A, DPFE7, DPFE8

Year Range: 2008-2010 Application: F Series

AP63435

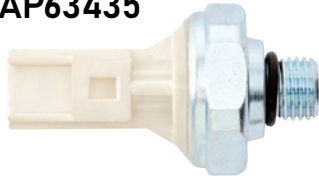

Engine Oil Pressure (EOP) Sensor

OEM Part Numbers: F81Z9278AA, SW5267

Year Range: 2008-2010 Application: F Series

AP63437

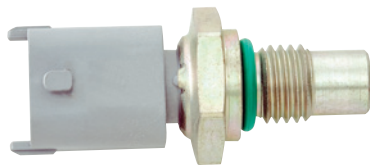

Engine Oil/Coolant/Fuel Temperature (EOT/ECT/FT) Sensor

OEM Part Numbers: 3C3Z10884AA, SW6052

Year Range: 2008-2010 Application: F Series

AP63463

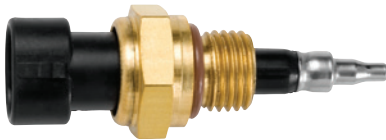

Intake Manifold Air Temperature (IAT) Sensor

OEM Part Numbers: 8C3Z12A697B, DY1112

Year Range: 2008-2010 Application: F Series

AP63470

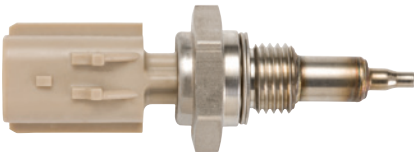

Exhaust Gas Recirculation (EGR) Temperature Sensor-Inlet

OEM Part Number: 8C3Z12B591A

Year Range: 2008-2010 Application: F Series

6.4L POWER STROKE

continued **Sensors**

Exhaust Gas Recirculation (EGR) Temperature Sensor-Outlet

OEM Part Number: 8C3Z12B591E

Year Range: 2008-2010 Application: F-250 / F-550

AP63471



Diesel Particulate Filter Pressure (DPFP) Sensor

OEM Part Numbers: 8C3Z9J460D, DPFE17

Year Range: 2008-2010 Application: F-250 / F-550

AP63473



Mass Air Flow/Intake Manifold Air Temperature (MAF/IAT) Sensor*

OEM Part Numbers: 7C3Z12B579A, AFLS179

Year Range: 2008-2010 Application: F-250 / F-550

AP63475



Manifold Absolute Pressure (MAP) Sensor

OEM Part Numbers: 8C349F479AA, 8C3Z9F479A, CX2161

Year Range: 2008-2010 Application: F Series

AP63476

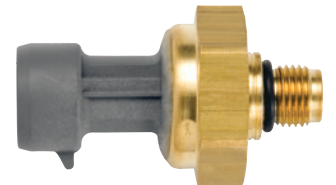

Transmission Fluid Temperature Sensor

OEM Part Number: 9C3Z7H141A

Year Range: 2008-2010 Application: F Series

AP63497



Actuators

Exhaust Gas Recirculation (EGR) Valve

OEM Part Number: 8C3Z9D475D

Year Range: 2008-2010 Application: F Series

AP63456

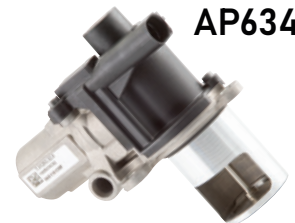

*Indicates products with a core charge.

6.4L POWER STROKE

Electrical Harness and Repair

AP0021



3 Wire Pigtail

OEM Part Number: 5C3Z12224A

Notes: Fits AP63423 Exhaust Back Pressure (EBP) Sensor.

Year Range:
2008-2010

Application:
F Series

AP0056



2 Wire Pigtail

Notes: Fits AP63437 Engine Oil/Coolant/Fuel Temperature (EOT/ECT/FT) Sensor.

Year Range:
2008-2010

Application:
F Series

EXCLUSIVEPARTS

AP0076



Engine Harness Connector Cover

Year Range:
2008-2010

Application:
F Series

EXCLUSIVEPARTS

AP63515



Injector Harness

OEM Part Number: 8C3Z9D930AA

Notes: Injector harness for the right side.

Year Range:
2008-2010

Application:
F-250 / F-550

AP63516



Injector Harness

OEM Part Number: 8C3Z9D930BA

Notes: Injector harness for the left side.

Year Range:
2008-2010

Application:
F-250 / F-550

Seal and Gasket Kits

AP0027



Injection Line and O-Ring Kit

OEM Part Number: 8C3Z9229A

Year Range:
2008-2010

Application:
F Series

6.4L POWER STROKE

continued Seal and Gasket Kits

Engine Oil Cooler Installation Kit

EXCLUSIVEKITS AP0041

Notes: Installation kit only. If engine oil cooler is needed see AP63468 Engine Oil Cooler Kit.

Year Range: 2008-2010
Application: F-250 / F-550

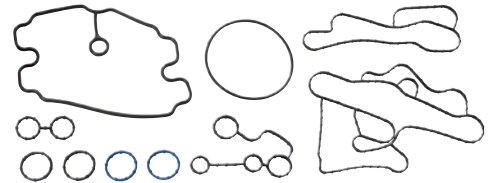

Exhaust Gas Recirculation (EGR) Valve O-Ring AP0042

OEM Part Number: 8C3Z9D476A

Year Range: 2008-2010
Application: F Series



Head Gasket Kit with Studs** Head Gasket Kit without Studs

EXCLUSIVEKITS AP0064
AP0065

Year Range: 2008-2010
Application: F Series

Kit Contents:

- 2 Cylinder Head Gaskets
- 2 Exhaust Manifold Gaskets
- 2 Rocker Housing Gaskets
- 2 Valve Cover Gaskets
- 8 Injector Seal Kits with Injection Lines
- 1 Intake Exhaust Gas Recirculation (EGR) Gasket Kit
- 1 Turbo Gasket Kit
- 1 Oil Cooler Gasket Kit
- **Includes Head Stud Kit

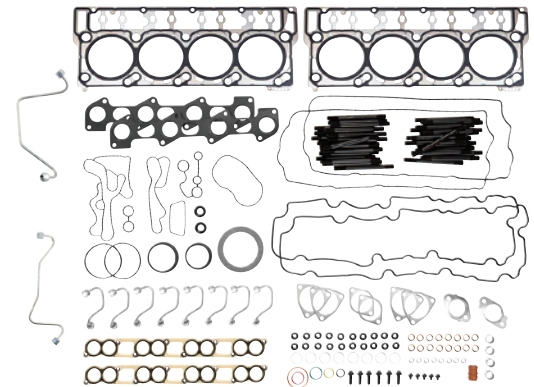

High-Pressure Fuel Pump (HPFP) Installation Kit

EXCLUSIVEKITS AP0071

Notes: Installation kit only. If pump is needed see AP63643 Remanufactured High-Pressure Fuel Pump (HPFP) Kit.

Year Range: 2008-2010
Application: F-250 / F-550

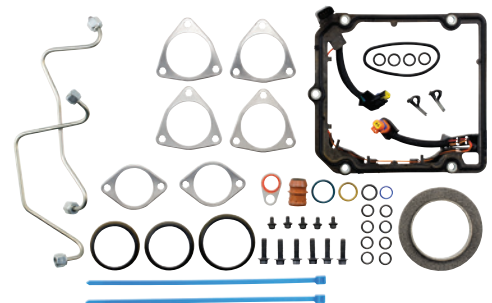

6.4L POWER STROKE

Seal and Gasket Kits continued

AP0134

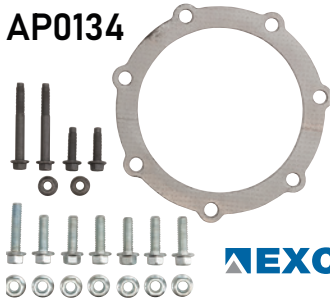

Diesel Particulate Filter (DPF) and Diesel Oxidation Catalyst (DOC) Installation Kit

Notes: Installation kit only. If DPF is needed see AP70000 or AP70001 Diesel Particulate Filter (DPF).

Year Range:
2008-2010

Application:
F Series

EXCLUSIVEKITS

AP63482

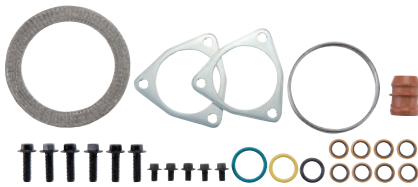

Turbo Installation Kit

OEM Part Number: 8C3Z9T514C

Year Range:
2008-2010

Application:
F-250 / F-550

Engine Accessories

AP63499



Fan Clutch

OEM Part Numbers: 7C3Z8A616F, YB3125

Notes: Without snow plow package.

Year Range:
2008-2010

Application:
F-250 / F-550

AP63518



Fan Clutch

OEM Part Numbers: 8C3Z8A616S, YB3126

Notes: With snow plow package.

Year Range:
2008-2010

Application:
F-250 / F-550

AP63517



Belt Tensioner

OEM Part Numbers: 7C3Z6B209B, BT91

Notes: Accessory belt tensioner.

Year Range:
2008-2010

Application:
F-250 / F-550

AP63519



Belt Tensioner

OEM Part Numbers: 7C3Z6B209E, BT122

Notes: Primary belt tensioner.

Year Range:
2008-2010

Application:
F-250 / F-550

6.4L POWER STROKE

continued Engine Accessories

Starter

OEM Part Numbers: 7C3Z11002AA, SA965

Year Range: 2008-2010 Application: F Series



AP83007

Filters

Horizontal Fuel Conditioning Module (HFCM)

OEM Part Numbers: 8C3Z9G282A, PFB95

Year Range: 2008-2010 Application: F-250 / F-550

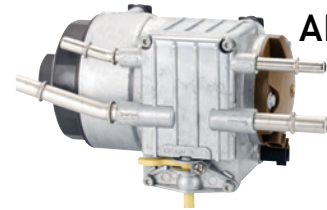

AP63450

Replacement Fuel Pump

OEM Part Number: 9C3Z9G282AC

Notes: Does not include housing.

Year Range: 2007-2010 Application: F-250 / F-550



PFP58529

Fuel Filter Element Service Kit

OEM Part Numbers: FD4609, FD4617, PFF5550

Notes: Primary and secondary.

Year Range: 2007-2010 Application: F-250 / F-550



PFF4617

Oil Filter Element Service Kit

OEM Part Number: FL2016

Year Range: 2008-2010 Application: F Series



PFL2016

RACOR

Oil Filter Cap

OEM Part Number: 3C3Z6766CA

Year Range: 2008-2010 Application: F Series



RK31821

RACOR

6.7L POWER STROKE

Modules

AP63525



Glow Plug Control Unit

OEM Part Numbers: BC3Z12B533A / B, DY1261, DY1297, DY1350

Year Range:
2011–2017

Application:
F Series

Fuel System Components

AP63527



Fuel Transfer Pump

OEM Part Numbers: BC3Z9G282E, PFB103

Notes: Engines built BEFORE 05/26/2015.

Year Range:
2012–2015

Application:
F Series

Engine Components

AP63540



Thermostat

OEM Part Numbers: BC3Z8575A / D, RT1205, RT1231

Notes: Main engine thermostat.

Year Range:
2011–2016

Application:
F Series

AP63541



Thermostat

OEM Part Numbers: BC3Z8575B, RT1206

Notes: High temperature right side thermostat.

Year Range:
2011–2016

Application:
F Series

AP63542



Thermostat

OEM Part Numbers: BC3Z8575C, RT1207

Notes: Low temperature left side thermostat.

Year Range:
2011–2016

Application:
F Series

6.7L POWER STROKE

continued Engine Components

Water Pump

OEM Part Numbers: BC3Z8501B / C, PW503 / 4

Notes: Water pump only. Fits secondary water pump housing for single or dual alternator.

Year Range:
2011-2017

Application:
F Series

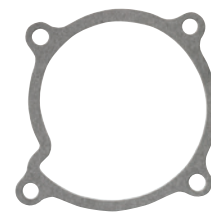

AP63505

Water Pump

OEM Part Numbers: BC3Z8501A, PW502

Notes: Primary water pump.

Year Range:
2011-2016

Application:
F Series



AP63507

Sensors

Ambient Air Temperature (AAT) Sensor

OEM Part Numbers: AU5Z12A647B, DY1160

Year Range:
2011-2016

Application:
F Series



AP63545

Camshaft Position (CMP) Sensor

OEM Part Numbers: BC3Z12K073A, DU92

Year Range:
2011-2017

Application:
F Series



AP63535

6.7L POWER STROKE

Sensors continued

AP63534



Crankshaft Position (CKP) Sensor

OEM Part Numbers: BC3Z6C315A, DY1148

Year Range: 2011–2017 Application: F Series

AP63528



Diesel Particulate Filter Pressure (DPFP) Sensor

OEM Part Numbers: DC3Z9J460D, DPFE24

Year Range: 2013–2016 Application: F Series

AP63539



Engine Oil Pressure (EOP) Sensor

OEM Part Numbers: 6U5Z9278D, SW6357

Year Range: 2011–2016 Application: F Series

AP63526



Exhaust Back Pressure (EBP) Sensor

OEM Part Numbers: BC3Z9J460B / E, DPFE22

Notes: Narrow frame chassis, located in the Diesel Particulate Filter (DPF).

Year Range: 2011–2015 Application: F-350 / F-550

AP63537



Exhaust Back Pressure/Diesel Particulate Filter Pressure (EBP/DPFP) Sensor

OEM Part Numbers: BC3Z9J460D, DPFE21

Notes: Wide frame chassis, located in the Diesel Particulate Filter (DPF).

Year Range: 2011–2016 Application: F Series

6.7L POWER STROKE

continued **Sensors**

Exhaust Gas Recirculation (EGR) Pressure Sensor

OEM Part Numbers: BC3Z9J460C, DPFE20

Year Range: 2011–2017 Application: F Series

AP63529

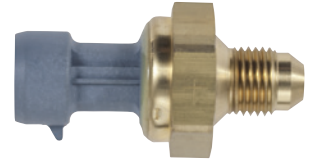

Intake Air/Charge Air Cooler Temperature (IAT/CACT) Sensor

OEM Part Numbers: 4R8Z12A697A, DY1146

Year Range: 2011–2017 Application: F Series

AP63544



Manifold Absolute Pressure (MAP) Sensor

OEM Part Numbers: BC3Z9F479B, CX2432

Year Range: 2011–2017 Application: F Series

AP63543



Mass Air Flow (MAF) Sensor*

OEM Part Numbers: BC3Z12B579A, AFLS166

Year Range: 2011–2016 Application: F Series

AP63524



Reductant Fluid Level Sensor

OEM Part Number: BC3Z5J225L

Year Range: 2011–2016 Application: F-250 / F-550

AP63521



Transmission Fluid Temperature Sensor

OEM Part Number: BC3Z7H141A

Year Range: 2011–2015 Application: F Series

AP63497



*Indicates products with a core charge.

6.7L POWER STROKE

Actuators

AP63522



Exhaust Gas Recirculation (EGR) Valve

OEM Part Numbers: BC3Z9D475C, CX2404

Notes: Used on narrow frame cab chassis models.

Year Range: 2011-2016 Application: F-350 / F-550

AP63523



Exhaust Gas Recirculation (EGR) Valve

OEM Part Numbers: BC3Z9D475D, CX2405

Notes: Used on wide frame pickup chassis models.

Year Range: 2011-2016 Application: F-250 / F-350

AP91000



Turbocharger Vane Actuator

OEM Part Numbers: 5C3Z6F089A / BA, 792593-0001

Year Range: 2011-2017 Application: F Series

Electrical Harness and Repair

AP0068



2 Wire Pigtail

Notes: Fits AP91000 Turbocharger Vane Actuator.

Year Range: 2011-2017 Application: F-250 / F-550

EXCLUSIVE PARTS

Seal and Gasket Kits

AP0087



Injection Line and O-Ring Kit

OEM Part Numbers: BC3Z9229A, CM5191

Notes: For cylinders 1, 2, 7, 8.

Year Range: 2011-2017 Application: F Series

6.7L POWER STROKE

continued Seal and Gasket Kits

Injection Line and O-Ring Kit

OEM Part Numbers: BC3Z9229B, CM5192

Notes: For cylinders 3, 4, 5, 6.

Year Range: 2011-2017 Application: F Series

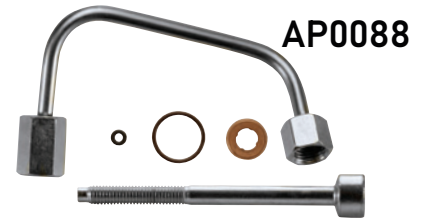

Head Gasket Kit with Studs** Head Gasket Kit without Studs

Year Range: 2011-2014 Application: F Series

Kit Contents:

- 2 Cylinder Head Gaskets
- 2 Exhaust Manifold Gaskets
- 2 Valve Cover Gaskets
- 8 Injection Line and O-Ring Kits
- 1 Turbo Mounting Kit
- 1 Fuel Rail Supply Tube
- **Includes Head Stud Kit



EXCLUSIVEKITS AP0152 AP0153

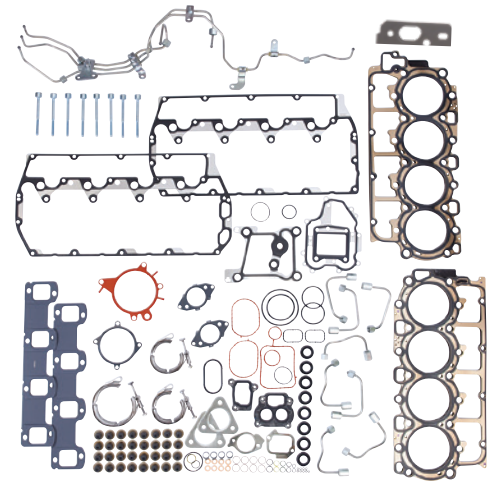

Turbocharger Installation Kit

Year Range: 2011-2014 Application: F Series

EXCLUSIVEKITS AP0156

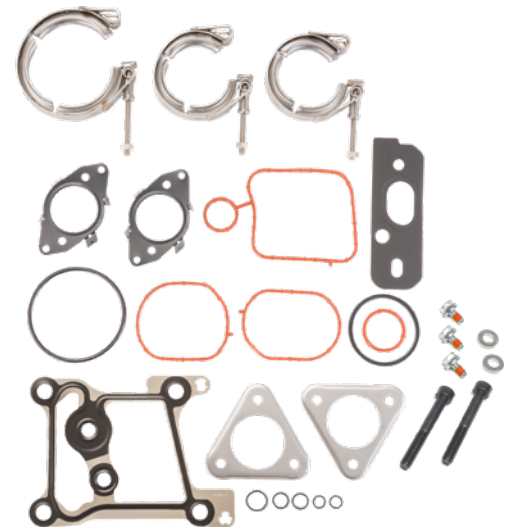

6.7L POWER STROKE

Seal and Gasket Kits continued

AP0157

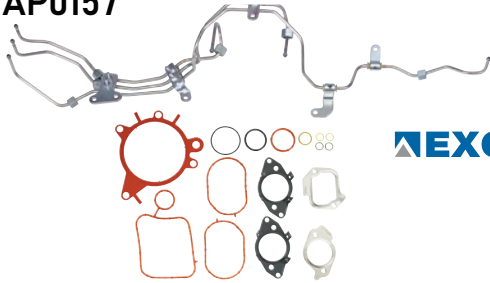

Fuel Injection Pump Installation Kit

Year Range:
2011-2014

Application:
F Series

EXCLUSIVEKITS

AP0166



Turbocharger Installation Kit

Year Range:
2011-2014

Application:
F Series

EXCLUSIVEKITS

AP0167



Turbocharger Clamp Kit

OEM Part Numbers: BC3Z8287A, BC3Z8287B

Year Range:
2011-2014

Application:
F Series

EXCLUSIVEKITS

Engine Accessories

AP83009



Alternator*

OEM Part Numbers: BC3Z10346A / D, GL8754, GL992

Notes: Bottom alternator on dual alternator chassis.

Year Range:
2011-2016

Application:
F Series

AP83010



Alternator*

OEM Part Numbers: BC3Z10346B, GL993

Notes: Single alternator chassis.

Year Range:
2011-2016

Application:
F Series

6.7L POWER STROKE

Alternator

OEM Part Numbers: BC3Z10346C, GL994
 Notes: Top alternator on dual alternator chassis.
 Year Range: 2011-2016

Application:
 F Series

*AP83011



Belt Tensioner

OEM Part Numbers: BC3Z6B209A / B, BT131
 Year Range: 2011-2017

Application:
 F Series

AP63538



*Indicates products with a core charge.continued

Vacuum Pump

OEM Part Numbers: BC3Z2A451A / B, BRPV-8 / 22
 Year Range: 2011-2016

Application:
 F Series

AP63725



Starter*

OEM Part Numbers: BC3Z11002A, SA1004
 Year Range: 2011-2017

Application:
 F Series

AP83008



Filters

Fuel Filter Element Service Kit

OEM Part Numbers: BC3Z9N184B, FD4615
 Notes: Primary and secondary.
 Year Range: 2011-2016

Application:
 F-250 / F-550

AP61004



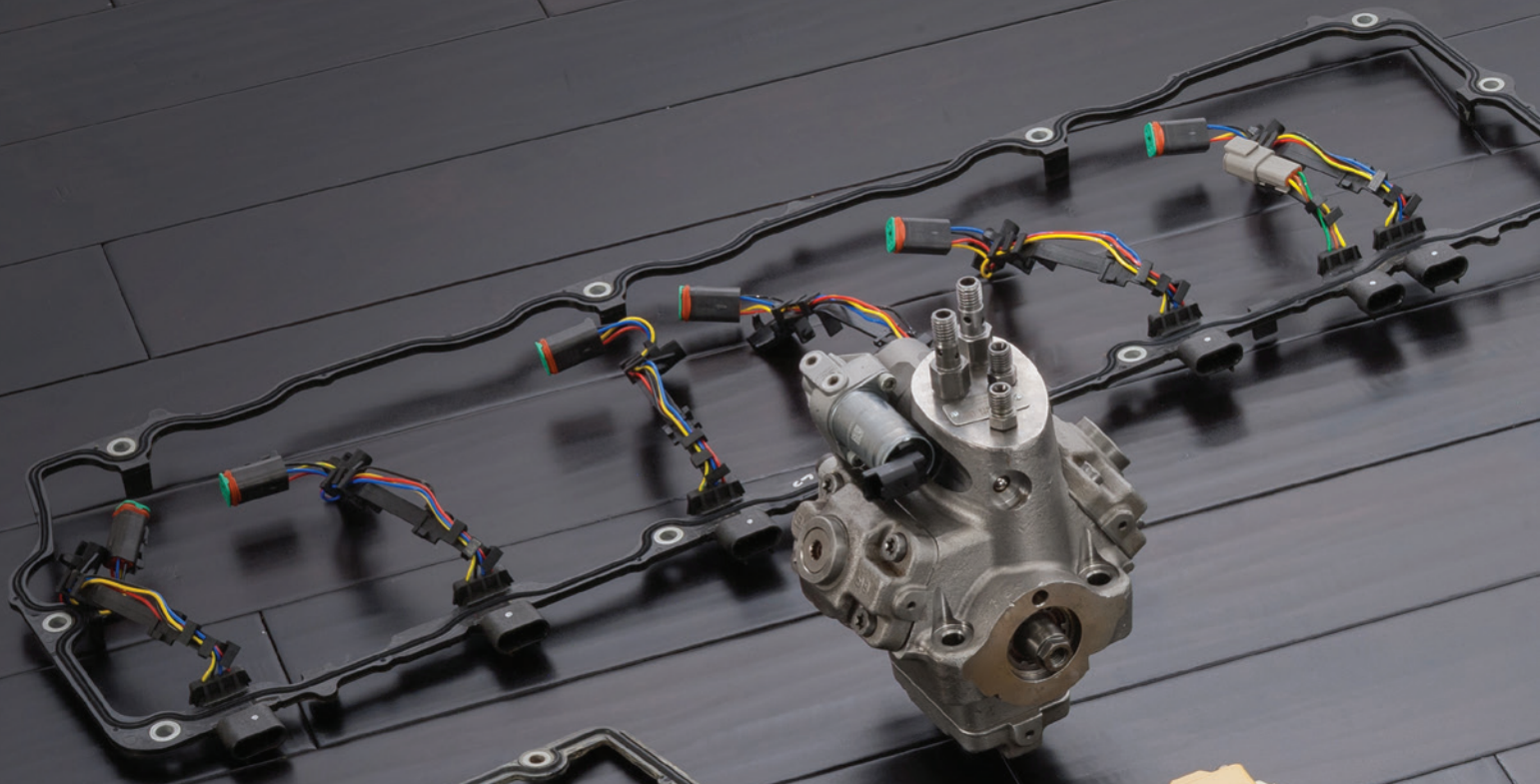

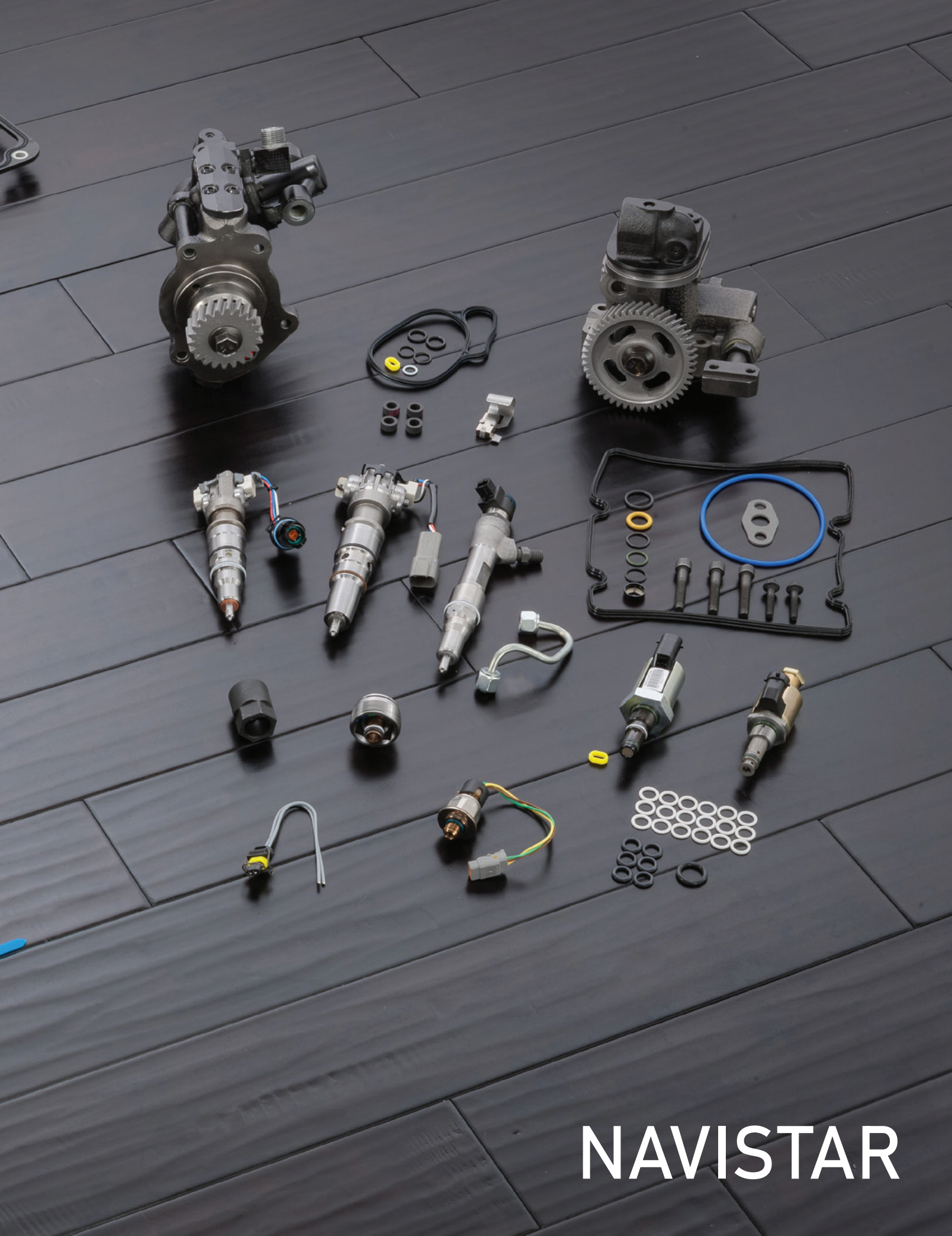

NAVISTAR



New OEM HEUI[®] injectors available exclusively through Alliant Power

- Brand new original equipment HEUI injectors
- Complete 1994 to 2003 Navistar mid-range coverage
- Available exclusively through Alliant Power
- 24-month, unlimited mileage warranty in Navistar applications



T444E

Injectors

HEUI Injector*

OEM Part Numbers: 1816187C3, 1818259C2, 1821752C1, 1821836C3, 1822800C95, 1822801C91

Year Range:	Application:	ESN Range:
1994-1996	T444E	500 to 460,194



AP63800AA

HEUI Injector*

OEM Part Numbers: 1822803C1, 1823561C1, 1824582C94, 1824583C97, 1825125C1, 1825126C1, 1833647C91

Notes: Prime (Split Shot) Injector.

Year Range:	Application:	ESN Range:
1997-1999	T444E	460,195 to 843,989



AP63801AB

HEUI Injector*

OEM Part Numbers: 1824474C2, 1822890C1, 1824472C1, 1824473C2, 1824455C94, 1824456C96

Year Range:	Application:
1994-1996	T444E: High Output 210 HP (HT) to 230 HP

AP63802AC

HEUI Injector*

OEM Part Numbers: 1823751C91, 1831487C92, 1831488C1, 1831489C1, 1831550C1, 1831551C1

Notes: Prime (Split Shot) Injector. Recommend replacing AD Injector in #8 cylinder location with AE Injector to eliminate "cackle". This became standard production in 2002.

Year Range:	Application:	ESN Range:
1999-2003	T444E	843,990 to 5,999,999



AP63803AD

HEUI Injector*

OEM Part Numbers: 1833639C1, 1833640C1, 1833644C1, 1833645C1, 1833646C92

Notes: Long Lead (LL or blue harness connector) Injector. Used in #8 cylinder location to eliminate "cackle."

Year Range:	Application:	ESN Range:
2002-2003	T444E	1,313,828 to 5,999,999

AP63804AE

EXCLUSIVEPARTS

* Indicates products with a core charge.

T444E

Fuel System Components

APM61067

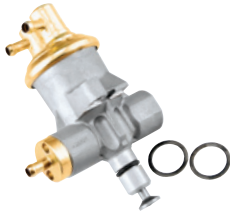

Fuel Transfer Pump-Mechanical

OEM Part Numbers: 1824415C93, 1826794C93

Notes: Includes two banjo gaskets.

Year Range: 1994-2003 Application: T444E

AP63409



Fuel Filter Heater Element

OEM Part Number: 1825186C91

Year Range: 1994-1998 Application: T444E

AP63410



Fuel Filter Heater Element

OEM Part Number: 1831196C92

Year Range: 1999-2003 Application: T444E

Engine Components

AP63411



HEUI Injector Sleeve-Brass

OEM Part Number: 1814376C1

Year Range: 1994-2003 Application: T444E

AP63452



Engine Oil Cooler

OEM Part Number: 1815904C2

Notes: Requires AP0004 Engine Oil Cooler O-ring and Gasket Kit for installation.

Year Range: 1994-2003 Application: T444E

AP63581

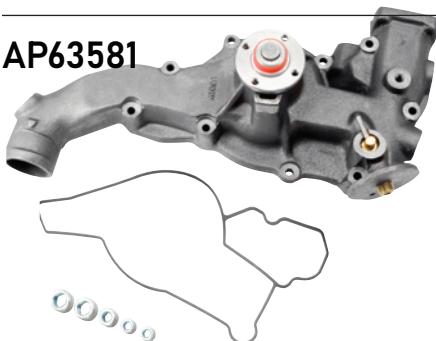

Water Pump

OEM Part Numbers: 1831676C92, 1889249C91

Notes: Includes mounting gasket and plugs.

Year Range: 1994-2003 Application: T444E

T444E

continued Engine Components

Remanufactured High-Pressure Oil Pump

OEM Part Numbers: 1825247C91, 1825260C91, 1825271C93, 2503701C91

Notes: Includes mounting gasket.

Year Range:	Application:	ESN Range:
See ESN	T444E	500 to 216,543



HP004X

Remanufactured High-Pressure Oil Pump

OEM Part Numbers: 1825248C91, 1825259C91, 2503703C91

Notes: Includes mounting gasket.

Year Range:	Application:	ESN Range:
See ESN	T444E	216,544 to 661,894



HP005X

Remanufactured High-Pressure Oil Pump

OEM Part Numbers: 1830857C91, 2503704C91

Notes: Includes mounting gasket.

Year Range:	Application:	ESN Range:
See ESN	T444E	661,895 to 843,989



HP007X

Remanufactured High-Pressure Oil Pump

OEM Part Numbers: 1831449C91, 2589446C91

Notes: Includes mounting gasket.

Year Range:	Application:	ESN Range:
See ESN	T444E	843,990 to End



HP008X

Sensors

Camshaft Position (CMP) Sensor

OEM Part Number: 1876736C91

Year Range:	Application:
1994-1996	T444E



AP63491

T444E

Sensors continued

AP63400

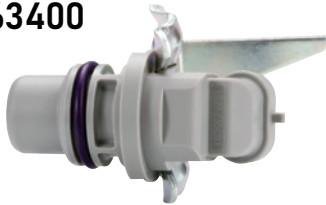

Camshaft Position (CMP) Sensor

OEM Part Numbers: 1825899C93, 1876735C91

Year Range: 1997-2003 Application: T444E

AP63403

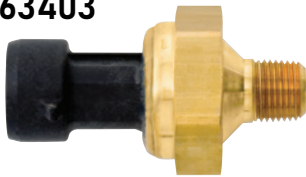

Exhaust Back Pressure (EBP) Sensor

OEM Part Number: 1850353C1

Year Range: 1997-2002 Application: T444E

AP63418



Injection Control Pressure (ICP) Sensor

OEM Part Number: 1807329C92

Year Range: 1994-2003 Application: T444E

Actuators

AP63401



Injection Pressure Regulator (IPR) Valve

OEM Part Numbers: 1824982C91, 1833798C91, 1841279C91

Notes: With edge filter.

Year Range: See ESN Application: T444E ESN Range: 500 to 216,543

AP63402



Injection Pressure Regulator (IPR) Valve

OEM Part Numbers: 1829856C91, 1836412C91, 1841086C91, 1841217C91

Notes: Without edge filter.

Year Range: See ESN Application: T444E ESN Range: 216,544 to End

AP63405



Glow Plug Relay

OEM Part Numbers: 1826634C94, 1831646C1

Year Range: 1994-2003 Application: T444E

T444E

Electrical Harness and Repair

Valve Cover Harness Connector Repair Kit

Notes: Repairs AP0016 Valve Cover Gasket Connector Pigtail.

Year Range: 1998-2003 Application: T444E

EXCLUSIVEKITS AP0009



Valve Cover Harness Connector Repair Kit

Notes: Repairs AP0015 Valve Cover Gasket Connector Pigtail.

Year Range: 1994-1997 Application: T444E

EXCLUSIVEKITS AP0010



Valve Cover Gasket Connector Pigtail **EXCLUSIVEPARTS**

AP0015

Year Range: 1994-1997 Application: T444E



Valve Cover Gasket Connector Pigtail **EXCLUSIVEPARTS**

AP0016

Year Range: 1998-2003 Application: T444E

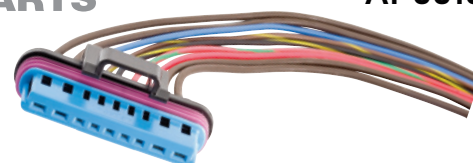

3 Wire Pigtail

AP0021

Notes: Fits AP63418 Injection Control Pressure (ICP) Sensor and AP63403 Exhaust Back Pressure (EBP) Sensor.

Year Range: 1994-2003 Application: T444E



2 Wire Pigtail

AP0068

Notes: Fits AP63401 and AP63402 Injection Pressure Regulator (IPR) Valves and all HEUI A Injectors.

Year Range: 1994-2003 Application: T444E



EXCLUSIVEPARTS

T444E

Electrical Harness and Repair continued

AP63413

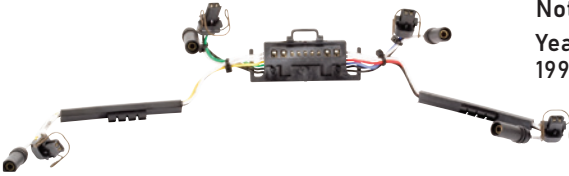

Internal Injector Harness

OEM Part Number: 1830844C93

Notes: Use with AP0014 Valve Cover Gasket Kit.

Year Range:
1998-2003

Application:
T444E

AP63414



Internal Injector Harness

OEM Part Number: 1815923C92

Notes: Use with AP0013 Valve Cover Gasket Kit.

Year Range:
1994-1997

Application:
T444E

Seal and Gasket Kits

AP0001

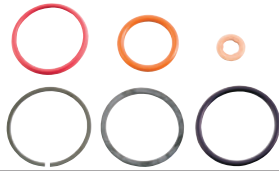

HEUI Injector Seal Kit

OEM Part Number: 1833564C92

Year Range:
1994-2003

Application:
T444E

AP0003

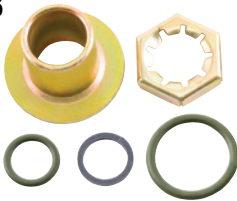

Injection Pressure Regulator (IPR) Valve Seal Kit

OEM Part Number: 1825806C91

Year Range:
1994-2003

Application:
T444E

AP0004 **EXCLUSIVEKITS**

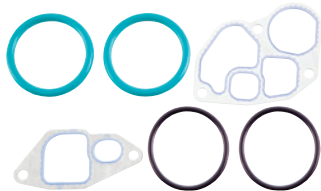

Engine Oil Cooler O-ring and Gasket Kit

Year Range:
1994-2003

Application:
T444E

AP0011 **EXCLUSIVEKITS**



High-Pressure Oil Pump Seal Kit

Year Range:
1994-2003

Application:
T444E

T444E

continued **Seal and Gasket Kits**

Valve Cover Gasket Kit

OEM Part Number: 1818350C2

Notes: Use with AP63414 Internal Injector Harness. Package of two.

Year Range: 1994-1997 Application: T444E

AP0013

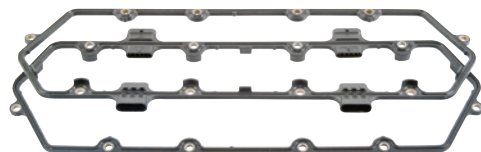

Valve Cover Gasket Kit

OEM Part Number: 1826703C1

Notes: Use with AP63413 Internal Injector Harness. Package of two.

Year Range: 1998-2003 Application: T444E

AP0014

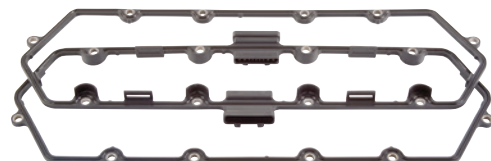

Turbo Installation Kit

OEM Part Number: 1831658C91

Year Range: 1999-2003 Application: T444E

AP63461

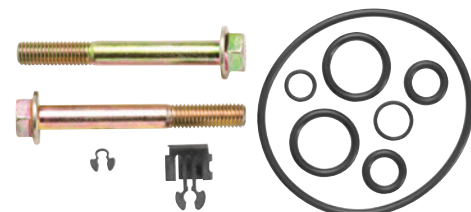

Filters

Fuel Filter Element Service Kit

OEM Part Number: 1822631C91

Year Range: 1994-2003 Application: T444E

PFF4595



Fuel Filter Top Cover

Year Range: 1994-2003 Application: T444E

RK31019





NEW

Injector Coils



NEW

Connector



NEW

Spool Valve

Alliant Power partners with PurePower Technologies®!

PurePower's industry leading remanufactured G2.8 injectors now available to the aftermarket through Alliant Power.

Remanufactured by PurePower Technologies

- 100% new coil and harness assemblies with vented slot technology
- 100% new spool valve and connector
- 24-month, unlimited mileage warranty in Navistar applications



VT365, VT275, MAXXFORCE 5

Injectors

PPT Remanufactured G2.8 Injector*
PPT New G2.8 Injector*

OEM Part Numbers: 1843089C95, 1843481C95, 1845879C91, 1878281C92, 1878282C92, 6901-PP, 6918-PP

Year Range: 2002½-2003 Application: VT365

PPT Remanufactured G2.8 Injector*
PPT New G2.8 Injector*

OEM Part Numbers: 1844751C2, 1845150C92, 1846692C2, 1877748C1, 1878284C91, 1878285C91, 1879998C91, 6902-PP, 6919-PP

Year Range: 2004-2006 Application: VT365
 2006 Application: VT275
 2007-2010 Application: MaxxFORCE 5

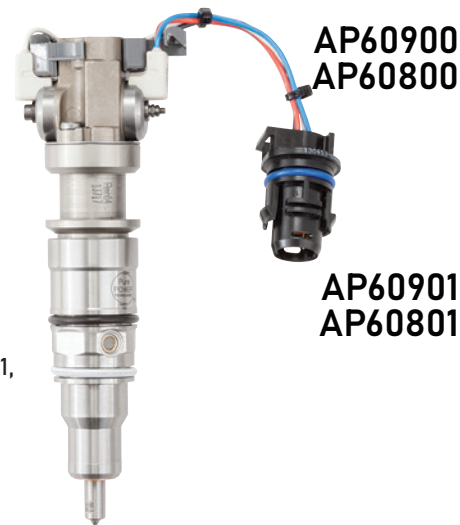

Fuel System Components

Fuel Filter Heater Element

OEM Part Number: 1831196C92

Year Range: 2003-2007 Application: VT365

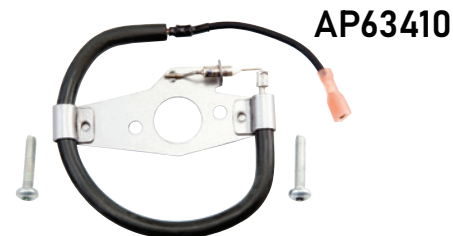

Engine Components

Oil Cooler/Exhaust Gas Recirculation (EGR) Cooler Kit*

AP63445

Notes: Includes AP63451 Engine Oil Cooler Kit and AP63446 Exhaust Gas Recirculation (EGR) Cooler Kit. Core is required only on the Exhaust Gas Recirculation (EGR) Cooler.

Year Range: 2004-2007 Application: VT365



*Indicates products with a core charge.



VT365, VT275, MAXXFORCE 5

Engine Components continued

AP63446 **EXCLUSIVE KITS** Exhaust Gas Recirculation (EGR) Cooler Kit*



OEM Part Number: 1845145C99

Notes: Includes AP63447 Exhaust Gas Recirculation (EGR) Cooler Intake Gasket Kit.

Year Range: 2004-2007 Application: VT365

AP63451

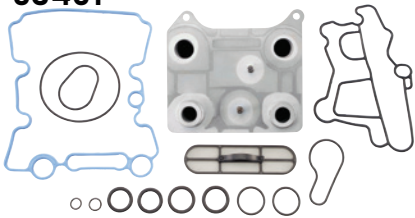

Engine Oil Cooler Kit

OEM Part Number: 1886511C93

Notes: Includes AP0039 Engine Oil Cooler Gasket Kit.

Year Range: 2003-2007 Application: VT365
 2006 VT275
 2007-2010 MaxxForce 5

AP63583

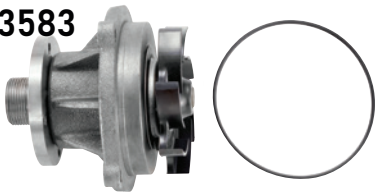

Water Pump

OEM Part Number: 1845002C91

Notes: Includes mounting gasket.

Year Range: 2002-2007 Application: VT365

AP63503

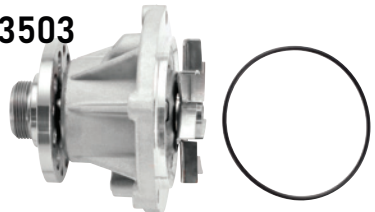

Water Pump

OEM Part Number: 5010118R91

Notes: Includes mounting gasket.

Year Range: 2006 Application: VT275
 2007-2010 MaxxForce 5

AP63661

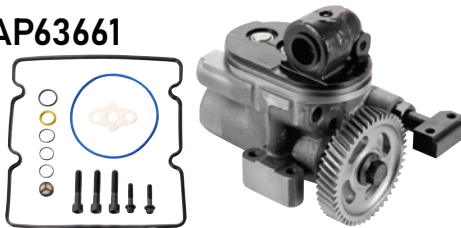

Remanufactured High-Pressure Oil Pump*

OEM Part Numbers: 1882919C92, 1878865C91, 1842410C91, 1847084C91, 4307329R91

Notes: Includes seal kit.

Year Range: 2004½-2007 Application: VT365

VT365, VT275, MAXXFORCE 5

continued Engine Components

Remanufactured High-Pressure Oil Pump*

OEM Part Numbers: 4307325R91, 1884357C92

Notes: Includes seal kit.

Year Range: 2006
Application: VT275

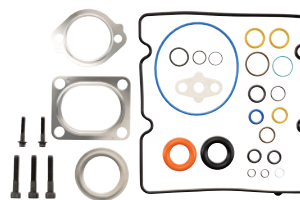

AP63662

Remanufactured High-Pressure Oil Pump*

OEM Part Numbers: 4307327R91, 1880313C94

Notes: Includes seal kit.

Year Range: 2007-2010
Application: MaxxForce 5

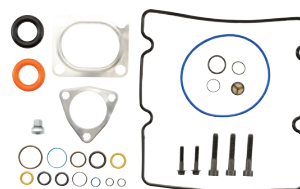

AP63663

Remanufactured High-Pressure Oil Pump

OEM Part Numbers: 1838828C91, 1843045C92, 2591022C91

Notes: Includes seal kit.

Year Range: 2002-2004
Application: VT365



HP032X

Sensors

Engine Speed/Position Sensor

OEM Part Number: 1828345C91

Notes: Crankshaft Speed/Position.

Year Range: 2003-2007
Application: VT365
2006
Application: VT275
2007-2010
Application: MaxxForce 5



AP63412

*Indicates products with a core charge.

VT365, VT275, MAXXFORCE 5

Sensors continued

AP63415



Engine Speed/Position Sensor

OEM Part Number: 1835985C92

Notes: Camshaft Speed/Position.

Year Range:	Application:
2003-2007	VT365
2006	VT275
2007-2010	MaxxForce 5

AP63435



Engine Oil Pressure (EOP) Sensor

OEM Part Number: 1831259C91

Year Range:	Application:
2006	VT275
2007-2010	MaxxForce 5

AP63474

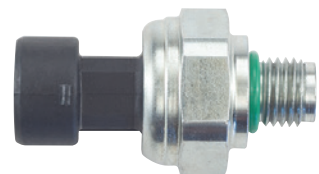

Engine Oil Pressure (EOP) Sensor

OEM Part Numbers: 1839415C91, 1837802C1, 1839832C1, 1872556C91

Notes: AP0021 3 Wire Pigtail can be used to repair the harness connector.

Year Range:	Application:
2004-2007	VT365

AP63437

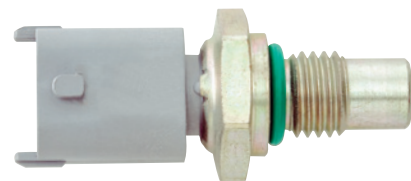

Engine Oil/Coolant/Fuel Temperature (EOT/ECT/FT) Sensor

OEM Part Number: 1836537C91

Year Range:	Application:
2003-2007	VT365
2006	VT275
2007-2010	MaxxForce 5

AP63403

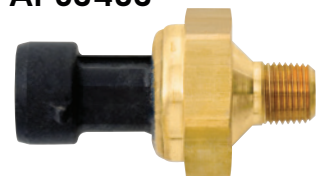

Exhaust Back Pressure (EBP) Sensor

OEM Part Number: 1850353C1

Year Range:	Application:
2003-2004	VT365

AP63408



Exhaust Back Pressure (EBP) Sensor

OEM Part Number: 1850352C2

Year Range:	Application:
2005-2007	VT365

VT365, VT275, MAXXFORCE 5

continued Sensors

Exhaust Back Pressure (EBP) Sensor**AP63423**

OEM Part Number: 1846480C2

Year Range:	Application:
2007-2010	MaxxForce 5

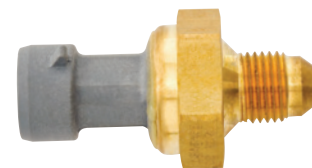
**Injection Control Pressure (ICP) Sensor****AP63407**

OEM Part Number: 1845274C92

Notes: Mounts below turbo.

Year Range:	Application:
2003-2004	VT365

**Injection Control Pressure (ICP) Sensor****AP63460**

OEM Part Numbers: 1845428C92, 1845427C2

Notes: Mounts on passenger side valve cover.

Year Range:	Application:
2004-2007	VT365
2006	VT275
2007-2010	MaxxForce 5

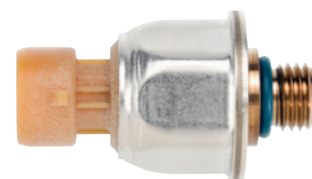
**Intake Manifold Air Temperature (IAT) Sensor****AP63462**

OEM Part Number: 1836539C91

Year Range:	Application:
2003-2007	VT365
2006	VT275

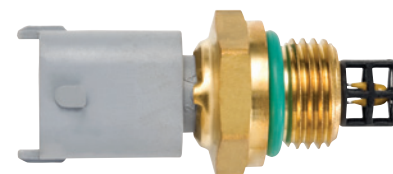
**Intake Manifold Air Temperature (IAT) Sensor****AP63463**

OEM Part Number: 1875838C91

Year Range:	Application:
2007-2010	MaxxForce 5

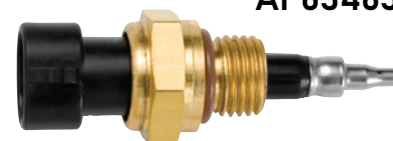
**Manifold Absolute Pressure (MAP) Sensor****AP63476**

OEM Part Number: 1846481C92

Year Range:	Application:
2007-2010	MaxxForce 5

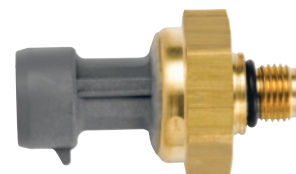

VT365, VT275, MAXXFORCE 5

Actuators

AP63416



Injection Pressure Regulator (IPR) Valve

OEM Part Number: 1839437C95

Notes: Without edge filter.

Year Range:	Application:
2003-2004	VT365

AP63417



Injection Pressure Regulator (IPR) Valve

OEM Part Number: 1846057C1

Notes: With edge filter.

Year Range:	Application:
2005-2007	VT365
2006	VT275
2007-2010	MaxxForce 5

AP63438R

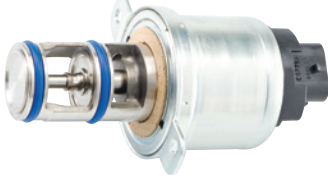

Remanufactured Exhaust Gas Recirculation (EGR) Valve*

OEM Part Number: 1846491C91, 5010682R91

Year Range:	Application:
2002½-2003	VT365

AP63459



Exhaust Gas Recirculation (EGR) Valve

OEM Part Number: 1846296C91

Year Range:	Application:
2004-2006	VT365

AP63479



Glow Plug Relay

OEM Part Number: 1840903C91

Year Range:	Application:
2003-2007	VT365
2006	VT275

*Indicates products with a core charge.

VT365, VT275, MAXXFORCE 5

Electrical Harness and Repair

3 Wire Pigtail

AP0021

Notes: Fits AP63407 and AP63460 Injection Control Pressure (ICP) Sensors, AP63403, AP63408, and AP63423 Exhaust Back Pressure (EBP) Sensors, AP63474 Engine Oil Pressure (EOP) Sensor, as well as AP63476 Manifold Absolute Pressure (MAP) Sensor.

Year Range:	Application:
2003-2007	VT365
2006	VT275
2007-2010	MaxxForce 5



2 Wire Pigtail

EXCLUSIVEPARTS AP0056

Notes: Fits AP63437 Engine Oil/Coolant/Fuel Temperature (EOT/ECT/FT) Sensor and AP63462 Intake Manifold Air Temperature (IAT) Sensor.

Year Range:	Application:
2003-2007	VT365
2006	VT275
2007-2010	MaxxForce 5



Injector Harness Connector

EXCLUSIVEPARTS AP0030

Year Range:	Application:
2003-2007	VT365
2006	VT275
2007-2010	MaxxForce 5



G2.8 Injector Connector

EXCLUSIVEPARTS AP0040

Notes: See Technical Bulletin APTB 03/14 for installation instructions.

Year Range:	Application:
2003-2007	VT365
2006	VT275
2007-2010	MaxxForce 5



Fuel Injection Control Module (FICM) Connector

EXCLUSIVEPARTS AP0018

Notes: Field data shows identification marks 1456315-6, 1437287-7, or X-3.

Year Range:	Application:
2003-2007	VT365
2006	VT275

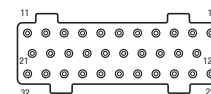

Fuel Injection Control Module (FICM) Connector

EXCLUSIVEPARTS AP0019

Notes: Field data shows identification marks 1456315-2, 1437287-6, or X-2.

Year Range:	Application:
2003-2007	VT365
2006	VT275

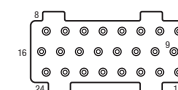

VT365, VT275, MAXXFORCE 5

Electrical Harness and Repair continued

AP0020

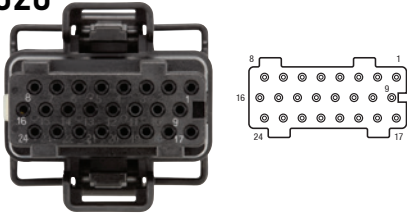

Fuel Injection Control Module (FICM) Connector

Notes: Field data shows identification marks 1456316-1, 1437287-5, or X-1.

Year Range:	Application:
2003-2007	VT365
2006	VT275

EXCLUSIVEPARTS

AP0068



2 Wire Pigtail

Notes: Fits AP63416 and AP63417 Injection Pressure Regulator (IPR) Valves and AP91000 Turbocharger Vane Actuator.

Year Range:	Application:
2003-2007	VT365
2006	VT275
2007-2010	MaxxFORCE 5

Seal and Gasket Kits

EXCLUSIVEKITS

AP0002



G2.8 Injector Seal Kit

OEM Part Number: 1843682C91

Notes: Includes high-pressure oil seal.

Year Range:	Application:
2002½-2007	VT365
2006	VT275
2007-2010	MaxxFORCE 5

AP0005



Exhaust Gas Recirculation (EGR) Valve O-ring Kit

OEM Part Number: 1840778C91

Year Range:	Application:
2003-2004	VT365

AP0023

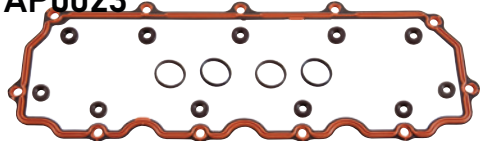

Valve Cover Gasket

OEM Part Number: 1838250C1

Year Range:	Application:
2003-2007	VT365

VT365, VT275, MAXXFORCE 5

continued Seal and Gasket Kits

Stand Pipe and Front Port Plug Seal Kit

Notes: Reseals one side.

Year Range:	Application:
2003-2007	VT365
2006	VT275
2007-2010	MaxxFORCE 5

EXCLUSIVEKITS AP0028



Injection Pressure Regulator (IPR) Valve Seal Kit

OEM Part Number: 1888696C93

Year Range:	Application:
2003-2007	VT365
2006	VT275
2007-2010	MaxxFORCE 5

AP0035



Engine Oil Cooler Gasket Kit

Year Range:	Application:
2003-2007	VT365
2006	VT275
2007-2010	MaxxFORCE 5

EXCLUSIVEKITS AP0039

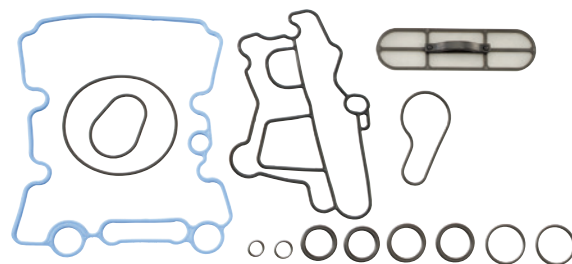

Exhaust Gas Recirculation (EGR) Valve Seal Kit

OEM Part Number: 1858088C92

Year Range:	Application:
2004-2006	VT365

AP0057



High-Pressure Oil Rail Seal Kit

Notes: AP0069 High-Pressure Oil Rail Socket required for installation.

Year Range:	Application:
2003-2007	VT365
2006	VT275
2007-2010	MaxxFORCE 5

EXCLUSIVEKITS AP0070



VT365, VT275, MAXXFORCE 5

Seal and Gasket Kits continued

AP63447 **EXCLUSIVEKITS** Exhaust Gas Recirculation (EGR) Cooler Intake Gasket Kit

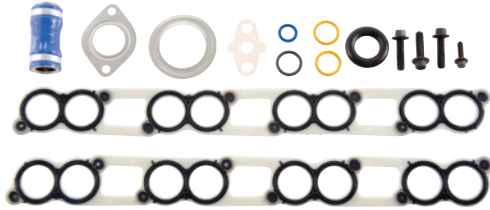

OEM Part Number: 1840702C97

Year Range:
2003-2007

Application:
VT365

AP63481

Turbo Installation Kit



OEM Part Number: 1840053C97

Year Range:
2004-2007

Application:
VT365

Filters

PFF31795

Fuel Filter Housing Cap



OEM Part Number: 1843057C92

Year Range:
2006
2007-2010

Application:
VT275
MaxxForce 5

PFF4616

Fuel Filter Element Service Kit



Notes: Primary and secondary.

Year Range:
2006
2007-2010

Application:
VT275
MaxxForce 5

PFL2016

Oil Filter Element Service Kit



Year Range:
2003-2007

Application:
VT365

VT365, VT275, MAXXFORCE 5

continued Filters

Oil Filter Cap

OEM Part Number: 1840754C91

Year Range: 2003-2007
 2006
 2007-2010

Application: VT365
 VT275
 MaxxForce 5

RACOR.



RK31821



Fuel Filter Element Service Kit

Year Range: 2003-2007

Application: VT365

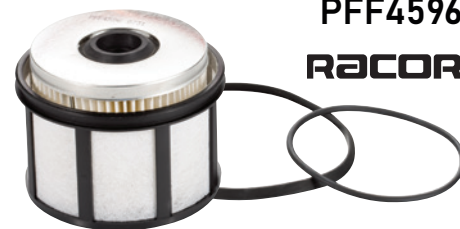

PFF4596

RACOR.

Fuel Filter Top Cover

Year Range: 2003-2007

Application: VT365



RK31449

RACOR.



BOLINGBROOK, IL 815.886.9900	PALATINE, IL 847.991.7867	PERU, IL 815.224.3439	CHICAGO, IL 773.475.9000	ROCKDALE, IL 815.744.7800	AGAWAM, MA 413.789.6600	ALLENTOWN, PA 610.395.3718
DEEP RIVER, CT 860.526.5941	PORTLAND, OR 503.283.5615	ALBANY, OR 541.248.3802	BOCA RATON, FL 561.241.0242	CONCORD, NC 704.721.6661	WASHINGTON, DC 708.514.2016	VISIT US ONLINE: SeidelDiesel Group.com





Alliant Power partners with PurePower Technologies®!

PurePower's industry leading remanufactured piezo injectors now available

to the aftermarket through Alliant Power.

- Remanufactured by PurePower Technologies
 - Piezos are 100% tested for performance and replaced with new when necessary
 - 24-month, unlimited mileage warranty in Navistar applications
- Brand new injectors also available



MAXXFORCE 7

Injectors

PPT Remanufactured Piezo Injector*
PPT New Piezo Injector*

OEM Part Numbers: 1873422C93, 4307381R91, 4307369R91, 5010359R93, 6903-PP, 6920-PP

Notes: Pre-2010 emission engines. Includes injection line.

Year Range: 2007-2010	Application: MaxxForce 7	ESN Range: 434,544 to 5,300,001
--------------------------	-----------------------------	------------------------------------



AP64900
AP64800

PPT Remanufactured Piezo Injector*
PPT New Piezo Injector*

OEM Part Numbers: 1883110C1, 1883111C92, 1899239C92, 5010889R91, 6904-PP, 6921-PP

Notes: Post 2010 emission engines. Includes injection line.

Year Range: 2010-2016	Application: MaxxForce 7	ESN Range: 5,300,002 to End
--------------------------	-----------------------------	--------------------------------

AP64901
AP64801



Engine Components

Engine Oil Cooler Kit

OEM Part Number: 1855839C95

Notes: Includes engine oil cooler and installation kit.

Year Range: 2007-2010	Application: MaxxForce 7
--------------------------	-----------------------------

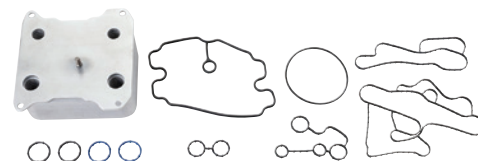

AP63468

**Click to Explore
 Mid-Range &
 Heavy-Duty
 Application Guide**



*Indicates products with a core charge.



MAXXFORCE 7

Engine Components continued

AP63644

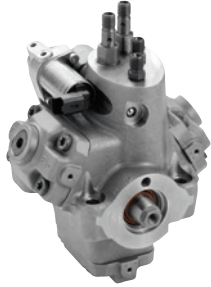

Remanufactured High-Pressure Fuel Pump (HPFP) Kit*

OEM Part Numbers: 4307291R91, 1876529C98, 1855860C94

Notes: Pre-2010 emission engines. Includes pump and installation kit. See Technical Bulletin APTB 09/16 for connector spacer removal and zip tie installation.

Year Range:
2007-2010

Application:
MaxxForce 7

EXCLUSIVEKITS

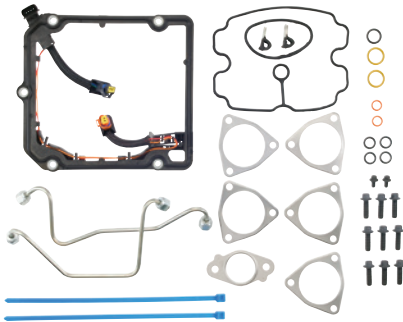

AP63646



Remanufactured High-Pressure Fuel Pump (HPFP) Kit*

OEM Part Numbers: 7080839C94, 5010756R92

Notes: Post 2010 emission engines. Includes pump and installation kit. See Technical Bulletin APTB 09/16 for connector spacer removal and zip tie installation.

Year Range:
2010-2016

Application:
MaxxForce 7

EXCLUSIVEKITS

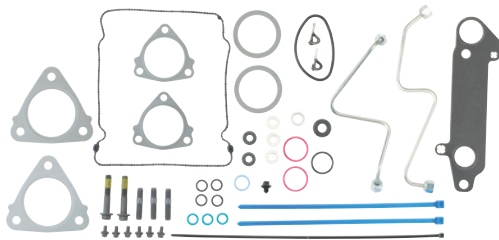

AP63480



Fuel Supply Hose

OEM Part Number: 7081021C1

Notes: Install on engines built BEFORE 04/06/2011.

Year Range:
2010-2016

Application:
MaxxForce 7

* Indicates products with a core charge.

MAXXFORCE 7

Sensors

Engine Speed/Position Sensor

OEM Part Number: 1828345C91

Notes: Crankshaft Speed/Position.

Year Range:
2007-2016Application:
MaxxForce 7

AP63412

Engine Speed/Position Sensor

OEM Part Number: 1835985C92

Notes: Camshaft Speed/Position.

Year Range:
2007-2016Application:
MaxxForce 7

AP63415

Fuel Rail Pressure Sensor

OEM Part Number: 1873400C92

Year Range:
2007-2016Application:
MaxxForce 7

AP63422

Exhaust Back Pressure (EBP) Sensor

OEM Part Numbers: 1846480C2, 1847913C91

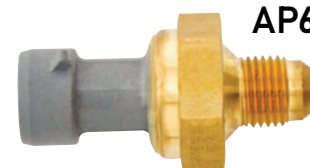
Year Range:
2007-2010Application:
MaxxForce 7

AP63423

Engine Oil Pressure (EOP) Sensor

OEM Part Numbers: 1839415C91, 1837802C1, 1839832C1, 1872556C91

Notes: AP0021 3 Wire Pigtail can be used to repair the harness connector.

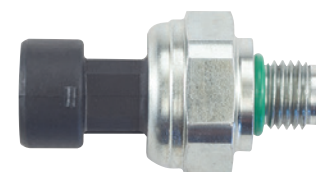
Year Range:
2007-2016Application:
MaxxForce 7

AP63474

Engine Oil/Coolant/Fuel Temperature (EOT/ECT/FT) Sensor

OEM Part Number: 1836537C91

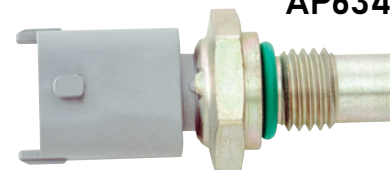
Year Range:
2007-2016Application:
MaxxForce 7

AP63437

Intake Manifold Air Temperature (IAT) Sensor

OEM Part Number: 1875838C91

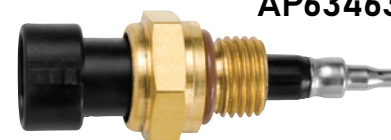
Year Range:
2007-2009Application:
MaxxForce 7

AP63463

MAXXFORCE 7

Sensors continued

AP63470

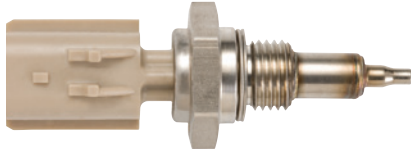

Exhaust Gas Recirculation (EGR) Temperature Sensor-Inlet

OEM Part Number: 1845988C1

Year Range: 2010-2016 Application: MaxxFace 7

AP63471



Exhaust Gas Recirculation (EGR) Temperature Sensor-Outlet

OEM Part Number: 1888560C1

Year Range: 2010-2016 Application: MaxxFace 7

AP63476

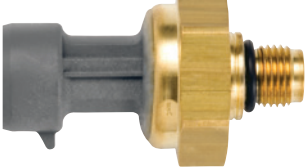

Manifold Absolute Pressure (MAP) Sensor

OEM Part Number: 1846481C92

Year Range: 2007-2016 Application: MaxxFace 7

Electrical Harness and Repair

AP0021



3 Wire Pigtail

Notes: Fits AP63423 Exhaust Back Pressure (EBP) Sensor and AP63476 Manifold Absolute Pressure (MAP) Sensor.

Year Range: 2007-2010 Application: MaxxFace 7

AP0056



2 Wire Pigtail

Notes: Fits AP63437 Engine Oil/Coolant//Fuel Temperature (EOT/ECT/FT) Sensor.

Year Range: 2007-2016 Application: MaxxFace 7

EXCLUSIVEPARTS

AP63515



Injector Harness

OEM Part Number: 1856010C95

Notes: Injector harness for the right side.

Year Range: 2008-2010 Application: MaxxFace 7

MAXXFORCE 7

continued Electrical Harness and Repair

Injector Harness

AP63516

OEM Part Number: 1856011C95

Notes: Injector harness for the left side.

Year Range: 2008-2010
Application: MaxxFORCE 7



Seal and Gasket Kits

Injection Line and O-ring Kit

AP0027

OEM Part Numbers: 1855644C3, 1886547C1, 1873425C93

Year Range: 2007-2016
Application: MaxxFORCE 7



Engine Oil Cooler Installation Kit

EXCLUSIVEKITS

AP0041

Notes: Installation kit only. If engine oil cooler is needed see AP63468 Engine Oil Cooler Kit.

Year Range: 2007-2010
Application: MaxxFORCE 7

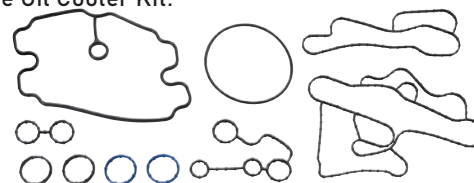

Exhaust Gas Recirculation (EGR) Valve O-ring

AP0042

OEM Part Number: 1847321C1

Year Range: 2007-2010
Application: MaxxFORCE 7



High-Pressure Fuel Pump (HPFP) Installation Kit

EXCLUSIVEKITS

AP0072

Notes: Pre-2010 emission engines. Installation kit only. If pump is needed see AP63644 Remanufactured High-Pressure Fuel Pump (HPFP) Kit.

Year Range: 2007-2010
Application: MaxxFORCE 7

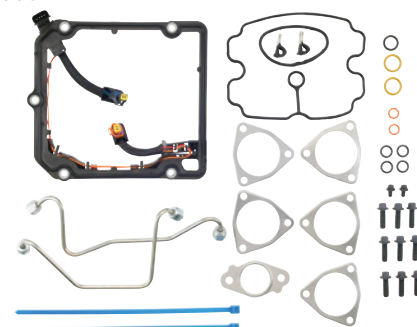

MAXXFORCE 7

Seal and Gasket Kits continued

AP0073 **EXCLUSIVEKITS**

High-Pressure Fuel Pump (HPFP) Installation Kit

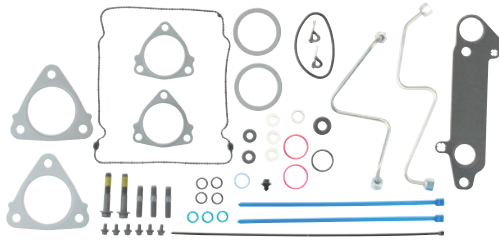

Notes: Post 2010 emission engines. Installation kit only. If pump is needed see AP63646 Remanufactured High-Pressure Fuel Pump (HPFP) Kit.

Year Range:
2010-2016

Application:
MaxxForce 7

AP63483

Turbo Installation Kit



OEM Part Number: 1876540C92

Notes: Pre-2010 emission engines.

Year Range:
2007-2010

Application:
MaxxForce 7

AP63484

Turbo Installation Kit



OEM Part Number: 1897455C93

Notes: Post 2010 emission engines.

Year Range:
2010-2016

Application:
MaxxForce 7

Engine Components

AP63585

Water Pump



OEM Part Number: 1832498C91, 1898956C91, 1886091C91, 1886066C1, 7081213C91

Notes: Includes necessary seals required for installation.

Year Range:
2007-2016

Application:
MaxxForce 7

Filters

PFL2016 **RACOR**



Oil Filter Element Service Kit

Year Range:
2007-2010

Application:
MaxxForce 7

MAXXFORCE 7

continued Filters

Oil Filter Cap

OEM Part Number: 1840754C91

Year Range: 2007-2010 Application: MaxxForce 7



RK31821

RACOR.

**Fuel Filter Kit**

OEM Part Number: 1876533C93

Notes: Pre-2010 emission engines.

Year Range: 2007-2010 Application: MaxxForce 7



PFF32715

Replacement Plastic Bowl with Drain

Notes: Pre-2010 emission engines.

Year Range: 2007-2010 Application: MaxxForce 7



RK21113

RACOR.

Fuel Filter Insert Kit

OEM Part Number: 1884207C92

Notes: Post 2010 emission engines.

Year Range: 2010-2016 Application: MaxxForce 7



PFF33286

RACOR.

Replacement Fuel Pump

OEM Part Numbers: 1884086C91, 7079720C91

Notes: Post 2010 emission engines.

Year Range: 2010-2016 Application: MaxxForce 7



PFP58529

RACOR.

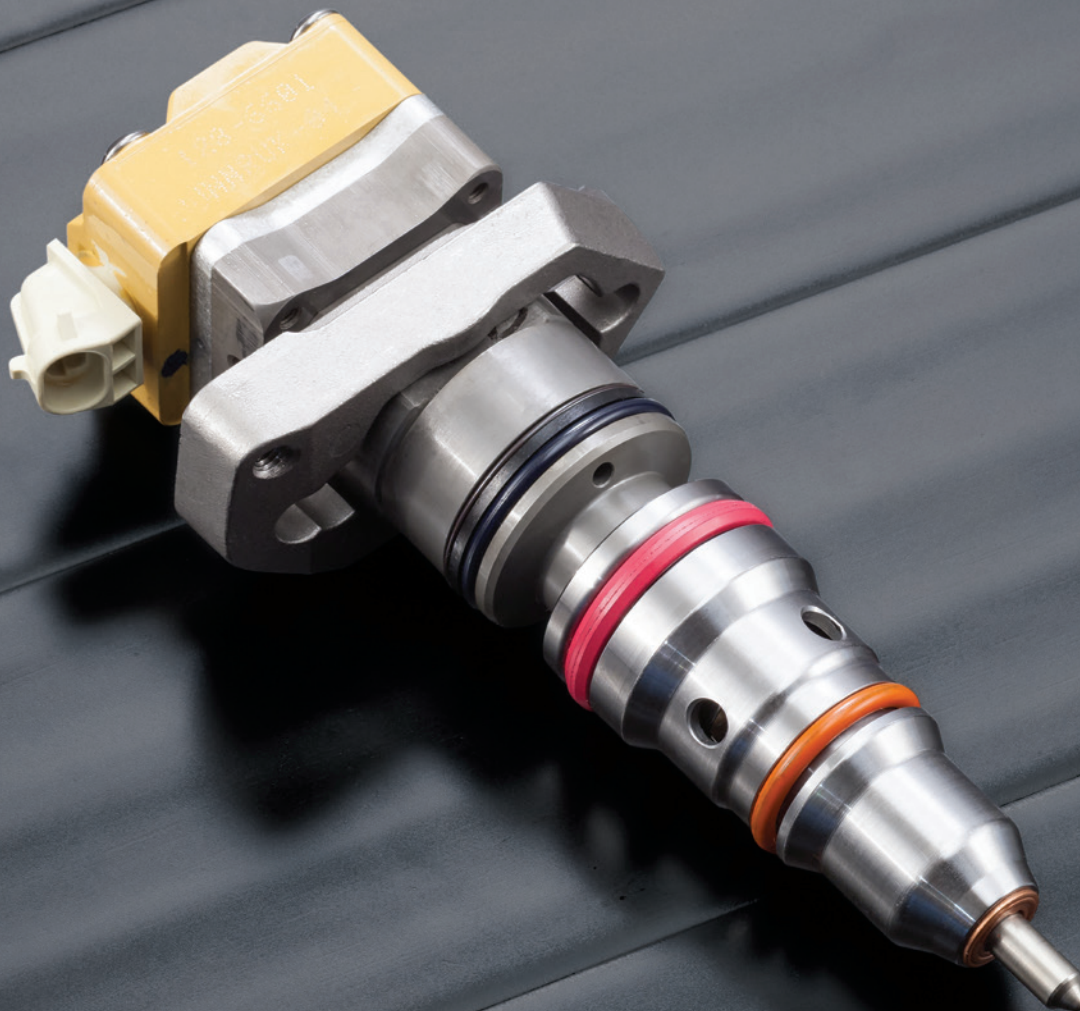

New OEM HEUI[®] injectors available exclusively through Alliant Power

- Brand new original equipment HEUI Injectors
- Complete 1995 to 2003 Navistar mid-range coverage
- Available exclusively through Alliant Power
- 24-month, unlimited mileage warranty in Navistar applications



DT466E, I530E, DT466/530, HT530

Injectors

HEUI Injector*

OEM Part Numbers: 1819834C1, 1823736C94, 1824917C2, 1824928C94, 2593588C91

Notes: Includes copper chamber gasket.

Year Range:	Application:	ESN Range:
1995-1997	DT466E: 230 HP (HT) to 250 HP (HT)	933,834 to 1,084,867

HEUI Injector*

OEM Part Numbers: 1824739C1, 1824742C91, 1824918C2, 1824929C94, 2593589C91

Notes: Includes copper chamber gasket.

Year Range:	Application:	ESN Range:
1995-1997	DT466E: 175 HP to 190 HP	933,834 to 1,028,710

HEUI Injector*

OEM Part Numbers: 1824740C1, 1824743C91, 1824919C2, 1824930C94, 2593590C91

Notes: Includes copper chamber gasket.

Year Range:	Application:	ESN Range:
1995-1997	DT466E: 195 HP (HT) to 230 HP (ST)	933,834 to 1,028,710

HEUI Injector*

OEM Part Numbers: 1824741C2, 1824744C94, 1824920C2, 1824931C94, 2593591C91

Notes: Includes copper chamber gasket.

Year Range:	Application:	ESN Range:
1995-1997	I530E: 250 (HP) (ST) to 300 HP (HT)	933,834 to 1,084,028

HEUI Injector*

OEM Part Numbers: 1824839C94, 1829336C1, 1829837C2, 1829838C94, 1829839C93, 1829926C2, 2593592C91

Notes: Includes copper chamber gasket.

Year Range:	Application:	ESN Range:
1997-1999	DT466E: 175 HP to 230 HP	1,028,711 to 1,194,038

HEUI Injector*

OEM Part Numbers: 1830145C91, 1830146C94, 1830147C2, 1830148C2, 2593593C91

Notes: Includes copper chamber gasket.

Year Range:	Application:	ESN Range:
1998-1999	I530E: 250 HP to 300 HP (HT)	1,084,029 to 1,134,350

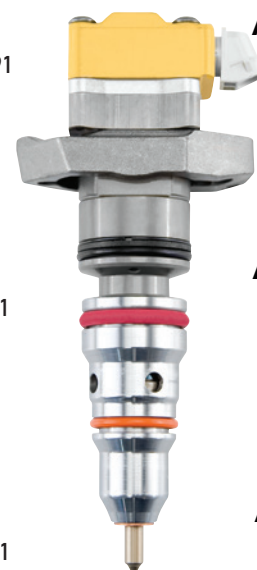

AP63805BA

AP63806BB

AP63807BC

EXCLUSIVEPARTS

AP63808BD

AP63809BE

AP63810BF

*Indicates products with a core charge.

DT466E, I530E, DT466/530, HT530

Injectors continued

AP63811BI

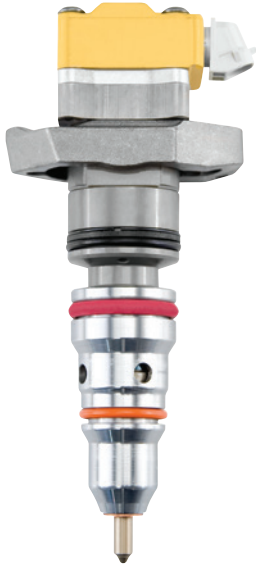

HEUI Injector*

OEM Part Numbers: 1830559C91, 1830560C2, 1830561C92, 1830562C2, 1830740C92, 1830741C92, 2593594C91, 2593595C91

Notes: Includes stainless steel and copper chamber gaskets.

Year Range:	Application:	ESN Range:
1999	DT466E: 175 HP to 250 HP (HT)	1,125,228 to 1,999,999
2000-2003	DT466: 175 HP to 250 HP (HT)	1,125,228 to 1,999,999

BG

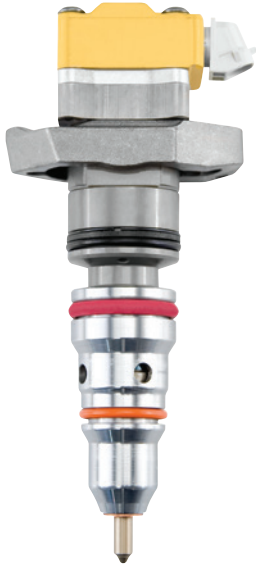

HEUI Injector

OEM Part Numbers: 1830155C91, 1830156C91, 1830157C1, 1830158C1, 1830570C91, 1830573C2, 2593596C91

Notes: Discontinued, supersedes to AP63812BJ HEUI Injector.

Year Range:	Application:	ESN Range:
1997-1999	DT466E: 230 HP (HT) to 250 HP (HT)	1,084,868 to 1,125,227

EXCLUSIVE PARTS

AP63812BJ

HEUI Injector*

OEM Part Numbers: 1830094C92, 1830570C92, 1830571C2, 1830572C93, 1830573C2, 2593596C91

Notes: Includes copper chamber gasket.

Year Range:	Application:	ESN Range:
1999	I530E: 230 HP (HT) to 300 HP (HT)	1,133,755 to 1,194,038

AP63813BN

HEUI Injector*

OEM Part Numbers: 1830691C1, 1830692C91, 1830693C1, 1830694C93, 2593597C91

Notes: Includes stainless steel chamber gasket.

Year Range:	Application:	ESN Range:
2000-2003	DT530, HT530: 250 HP to 340 HP (HT)	1,194,039 to 1,999,999

AP63814BP

HEUI Injector*

OEM Part Numbers: 1836250C1, 1836251C91, 1836252C91, 1836253C1

Notes: Includes stainless steel chamber gasket.

Year Range:	Application:
2000 and Later	DT466 Transit

* Indicates products with a core charge.

DT466E, I530E, DT466/530, HT530

Engine Components

HEUI Injector Sleeve–Stainless Steel**AP63434**

OEM Part Number: 1818778C3

Notes: Engines built ON or AFTER 03/1996.

Year Range:	Application:
1996-1999	DT466E, I530E
2000-2003	DT466 / 530, HT530

**Engine Oil Cooler****AP63452**

OEM Part Number: 1815904C2

Year Range:	Application:
1995-1999	DT466E, I530E
2000-2003	DT466 / 530, HT530

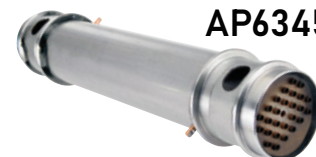
**Water Pump****AP63580**

OEM Part Numbers: 1817687C92, 1821935C3, 1830606C94

Notes: Includes mounting gasket. Engines built ON or AFTER 09/1993.

Year Range:	Application:
1994-1999	DT466E, I530E
2000-2003	DT466 / 530, HT530

**Remanufactured High-Pressure Oil Pump****HP020X**

OEM Part Numbers: 1830177C92, 1842722C91

Notes: Includes mounting gasket. 6.5cc pump.

Year Range:	Application:
1994-1999	I530E: 230 HP (HT) to 300 HP
2000-2003	DT466 / 530, HT530: 230 HP (HT) to 300 HP

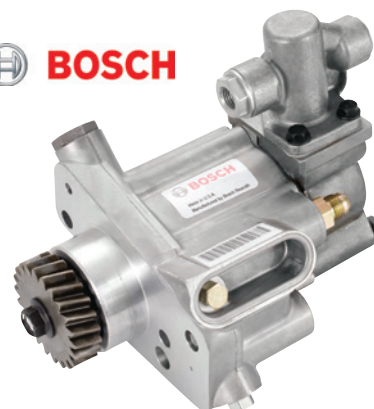
BOSCH
**Remanufactured High-Pressure Oil Pump****HP021X**

OEM Part Numbers: 1825681C95, 1842721C91

Notes: Includes mounting gasket. 5.3cc pump.

Year Range:	Application:
1994-1999	DT466E: 175 HP to 230 HP
2000-2003	DT466: 175 HP to 230 HP

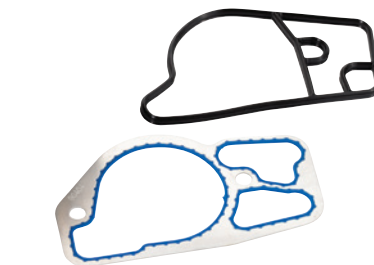
**Remanufactured High-Pressure Oil Pump****HP022X**

OEM Part Numbers: 1842723C91, 1826458C92

Notes: Includes mounting gasket. 7.0cc pump.

Year Range:	Application:
1994-1999	I530E: 300 HP to 330 HP
2000-2003	DT530, HT530: 300 HP to 330 HP



DT466E, I530E, DT466/530, HT530

Sensors

AP63429

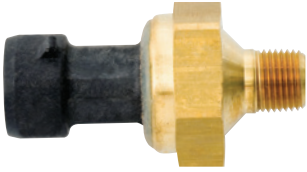

Pressure Sensor

OEM Part Number: 1840078C1

Notes: Manifold Absolute Pressure (MAP) Sensor. Mounts on intake manifold.

Year Range:
1998-2003

Application:
DT466E, I530E, DT466 / 530, HT530

AP63465

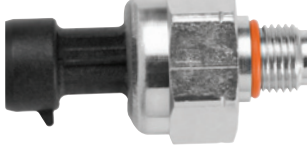

Injection Control Pressure (ICP) Sensor

OEM Part Number: 1830669C92

Year Range:
See ESN

Application:
DT466E, I530E,
DT466 / 530, HT530

ESN Range:
1,134,351 to 1,999,999

AP63466

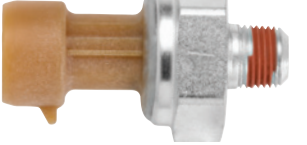

Engine Oil Pressure (EOP) Sensor

OEM Part Number: 1807369C2

Year Range:
See ESN

Application:
DT466E, I530E,
DT466 / 530, HT530

ESN Range:
1,126,949 to 1,999,999

Actuators

AP63401



Injection Pressure Regulator (IPR) Valve

OEM Part Numbers: 1824982C91, 1833798C91, 1841279C91

Notes: With edge filter.

Year Range:
1994-1995½

Application:
DT466E, I530E

ESN Range:
0 to 998,705

AP63402



Injection Pressure Regulator (IPR) Valve

OEM Part Numbers: 1829856C91, 1836412C91, 1841086C91, 1841217C91

Notes: Without edge filter.

Year Range:
1995½-2003
2000-2003

Application:
DT466E, I530E
DT466 / 530, HT530

ESN Range:
998,706 to 1,999,999
998,706 to 1,999,999

DT466E, I530E, DT466/530, HT530

Electrical Harness and Repair

3 Wire Pigtail

AP0021

Notes: Fits AP63465 Injection Control Pressure (ICP) Sensor and AP63466 Engine Oil Pressure (EOP) Sensor.

Year Range: 1994-2003
 Application: DT466E, I530E, DT466 / 530, HT530



2 Wire Pigtail

AP0068

Notes: Fits AP63401 and AP63402 Injection Pressure Regulator (IPR) Valves and all HEUI B Injectors.

Year Range: 1994-1999
 2000-2003
 Application: DT466E, I530E
 DT466 / 530, HT530



Internal Injector Harness

AP63464

OEM Part Numbers: 1889905C91, 30360R1, 1824908C1

Notes: Includes mounting bolts.

Year Range: 1994-2003
 Application: DT466E, I530E, DT466 / 530, HT530



Seal and Gasket Kits

HEUI Injector Seal Kit

AP0001

OEM Part Number: 1833564C92

Year Range: 1994-1999
 2000-2003
 Application: DT466E, I530E
 DT466 / 530, HT530



Injection Pressure Regulator (IPR) Valve Seal Kit

AP0003

OEM Part Number: 1825806C91

Year Range: 1994-1999
 2000-2003
 Application: DT466E, I530E
 DT466 / 530, HT530

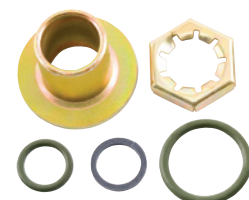

DT466E, I530E, DT466/530, HT530

Seal and Gasket Kits continued

AP0006

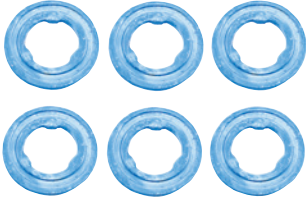

Stainless Steel Chamber Gaskets

OEM Part Number: 1830317C1

Notes: Package of six.

Year Range:
As Required

Application:
DT466E, I530E, DT466 / 530, HT530

AP0036

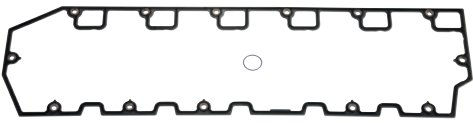

Valve Cover Gasket

OEM Part Numbers: 1820909C1, 1825602C91

Year Range:
1994-1999
2000-2003

Application:
DT466E, I530E
DT466 / 530, HT530

AP0038 **EXCLUSIVE KITS**



Primer Pump Seal Kit

Year Range:
1995-2003

Application:
DT466E, I530E, DT466 / 530, HT530



BOLINGBROOK, IL 815.886.9900	PALATINE, IL 847.991.7867	PERU, IL 815.224.3439	CHICAGO, IL 773.475.9000	ROCKDALE, IL 815.744.7800	AGAWAM, MA 413.789.6600	ALLENTOWN, PA 610.395.3718
DEEP RIVER, CT 860.526.5941	PORTLAND, OR 503.283.5615	ALBANY, OR 541.248.3802	BOCA RATON, FL 561.241.0242	CONCORD, NC 704.721.6661	WASHINGTON, DC 708.514.2016	VISIT US ONLINE: SeidelDiesel Group.com

DT466E, I530E, DT466/530, HT530



BOLINGBROOK, IL 815.886.9900	PALATINE, IL 847.991.7867	PERU, IL 815.224.3439	CHICAGO, IL 773.475.9000	ROCKDALE, IL 815.744.7800	AGAWAM, MA 413.789.6600	ALLENTOWN, PA 610.395.3718
DEEP RIVER, CT 860.526.5941	PORTLAND, OR 503.283.5615	ALBANY, OR 541.248.3802	BOCA RATON, FL 561.241.0242	CONCORD, NC 704.721.6661	WASHINGTON, DC 708.514.2016	VISIT US ONLINE: SeidelDiesel Group.com

PERKINS, DETROIT DIESEL, AGCO

Injectors

AP63805BA



HEUI Injector*

OEM Part Numbers: 1819834C1, 1823736C94, 1824917C2, 1824928C94, 2593588C91

Notes: Includes copper chamber gasket.

Year Range:	Engine:
1995-1997	7.6L Perkins 1300 Series EDi

AP63808BD

HEUI Injector*

OEM Part Numbers: 1824741C2, 1824744C94, 1824920C2, 1824931C94, 2593591C91

Notes: Includes copper chamber gasket.

Year Range:	Engine:
1995-1997	8.7L Perkins 1300 Series EDi

AP63810BF

EXCLUSIVE PARTS

HEUI Injector*

OEM Part Numbers: 1830145C91, 1830146C94, 1830147C2, 1830148C2, 2593593C91

Notes: Includes copper chamber gasket.

Year Range:	Engine:
1998-1999	8.7L Perkins 1300 Series EDi
1998-1999	8.7L Detroit Diesel Series 40E
1998-1999	8.7L AGCO 9675

AP63811BI

HEUI Injector*

OEM Part Numbers: 1830559C91, 1830560C2, 1830561C92, 1830562C2, 1830740C92, 1830741C92, 2593594C91, 2593595C91

Notes: Includes stainless steel and copper chamber gaskets.

Year Range:	Engine:
1999-2003	7.6L Perkins 1300 Series EDi

AP63812BJ

HEUI Injector*

OEM Part Numbers: 1830094C92, 1830570C92, 1830571C2, 1830572C93, 1830573C2, 2593596C91

Notes: Includes copper chamber gasket.

Year Range:	Engine:
1999	8.7L Perkins 1300 Series EDi
1999	8.7L Detroit Diesel Series 40E

PERKINS, DETROIT DIESEL, AGCO

continued **Injectors**

HEUI Injector*

OEM Part Numbers: 1830691C1, 1830692C91, 1830693C1, 1830694C93, 2593597C91

Notes: Includes stainless steel chamber gasket.

Year Range:	Engine:
2000-2003	8.7L Perkins 1300 Series EDi
2000-2003	8.7L Detroit Diesel Series 40E



AP63813BN

HEUI Injector*

OEM Part Numbers: 1836250C1, 1836251C91, 1836252C91, 1836253C1

Notes: Includes stainless steel chamber gasket.

Year Range:	Engine:
2000 and Later	7.6L Detroit Diesel Series 40E

AP63814BP

EXCLUSIVE PARTS

Seal and Gasket Kits

HEUI Injector Seal Kit

OEM Part Number: 1833564C92

Year Range:	Engine:
1995-1997	7.6L Perkins 1300 Series EDi
1999-2003	7.6L Perkins 1300 Series EDi
1995-2003	8.7L Perkins 1300 Series EDi
1998-2003	8.7L Detroit Diesel Series 40E
2000 and Later	7.6L Detroit Diesel Series 40E
1998-1999	8.7L AGCO 9675



AP0001



BOLINGBROOK, IL 815.886.9900	PALATINE, IL 847.991.7867	PERU, IL 815.224.3439	CHICAGO, IL 773.475.9000	ROCKDALE, IL 815.744.7800	AGAWAM, MA 413.789.6600	ALLENTOWN, PA 610.395.3718
DEEP RIVER, CT 860.526.5941	PORTLAND, OR 503.283.5615	ALBANY, OR 541.248.3802	BOCA RATON, FL 561.241.0242	CONCORD, NC 704.721.6661	WASHINGTON, DC 708.514.2016	VISIT US ONLINE: SeidelDiesel Group.com

*Indicates products with a core charge.



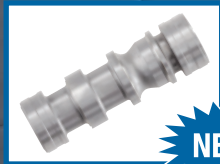

NEW

Spool Valve



NEW

Injector Coils



NEW

Connector

Alliant Power partners with PurePower Technologies®!

PurePower's industry leading remanufactured G2.9 injectors now available to the aftermarket through Alliant Power.

- Remanufactured by PurePower Technologies
 - 100% new injector coils, spool valve and connectors
 - 24-month, unlimited mileage warranty
- Complete 2004 to 2017 Navistar mid-range coverage



DT466/570 HT570, MAXXFORCE DT/9/10, N9/N10

Injectors

PPT Remanufactured G2.9 Injector*
PPT New G2.9 Injector*

OEM Part Numbers: 1842576C94, 5010656R92, 1841491C91, 1842223C91, 6905-PP, 6922-PP

Notes: Installation requires removal of high-pressure oil rail. Use AP0025 High-Pressure Oil Rail Seal Kit when reinstalling oil rail.

Year Range:	Application:	ESN Range:
2004	DT466: 210 HP to 225 HP	2,000,001 to 2,999,999

AP66976
AP66876

PPT Remanufactured G2.9 Injector*
PPT New G2.9 Injector*

OEM Part Numbers: 1842577C94, 5010657R92, 1842224C91, 6906-PP, 6923-PP

Notes: Installation requires removal of high-pressure oil rail. Use AP0025 High-Pressure Oil Rail Seal Kit when reinstalling oil rail.

Year Range:	Application:	ESN Range:
2004	DT466: 245 HP to 285 HP (HT)	2,000,001 to 2,999,999
2005	DT466: 210 HP to 285 HP	2,000,001 to 2,999,999

AP66977
AP66877

PPT Remanufactured G2.9 Injector*
PPT New G2.9 Injector*

OEM Part Numbers: 1842578C95, 5010658R92, 1842225C91, 6907-PP, 6924-PP

Notes: Installation requires removal of high-pressure oil rail. Use AP0025 High-Pressure Oil Rail Seal Kit when reinstalling oil rail.

Year Range:	Application:	ESN Range:
2004-2005	DT570: 285 HP to 330 HP	2,000,001 to 2,999,999

AP66978
AP66878

PPT Remanufactured G2.9 Injector*
PPT New G2.9 Injector*

OEM Part Numbers: 1842579C95, 5010659R92, 1842226C91, 6908-PP, 6925-PP

Notes: Installation requires removal of high-pressure oil rail. Use AP0025 High-Pressure Oil Rail Seal Kit when reinstalling oil rail.

Year Range:	Application:	ESN Range:
2004-2005	HT570: 295 HP to 340 HP (HT)	2,000,001 to 2,999,999

purePOWER
 TECHNOLOGIES **AP66979**
AP66879

PPT Remanufactured G2.9 BANG Injector*
PPT New G2.9 BANG Injector*

OEM Part Numbers: 1848489C92, 5010983R91, 6909-PP, 6926-PP

Notes: Installation requires removal of high-pressure oil rail. Use AP0025 High-Pressure Oil Rail Seal Kit when reinstalling oil rail.

Year Range:	Application:
2006	DT466: 210 HP to 285 HP

AP66989
AP66889

PPT Remanufactured G2.9 BANG Injector*
PPT New G2.9 BANG Injector*

OEM Part Numbers: 1848492C92, 5010984R91, 6910-PP, 6927-PP

Notes: Installation requires removal of high-pressure oil rail. Use AP0025 High-Pressure Oil Rail Seal Kit when reinstalling oil rail.

Year Range:	Application:
2006	DT570: 285 HP to 330 HP

AP66992
AP66892



*Indicates products with a core charge.

DT466/570 HT570, MAXXFORCE DT/9/10, N9/N10

Injectors continued

**AP66995
AP66895**



PPT Remanufactured G2.9 BANG Injector*
PPT New G2.9 BANG Injector*

OEM Part Numbers: 1848495C92, 5010985R91, 6911-PP, 6928-PP

Notes: Installation requires removal of high-pressure oil rail. Use AP0025 High-Pressure Oil Rail Seal Kit when reinstalling oil rail.

Year Range: 2006 Application: HT570: 295 HP to 340 HP (HT)

**AP66918
AP66818**

PPT Remanufactured G2.9 Injector*
PPT New G2.9 Injector*

OEM Part Numbers: 1848718C93, 5010561R93, 6912-PP, 6929-PP

Notes: Installation requires removal of high-pressure oil rail. Use AP0025 High-Pressure Oil Rail Seal Kit when reinstalling oil rail.

Year Range: 2007-2010 Application: MaxxFORCE DT: 210 HP to 300 HP ESN Range: 3,000,001 to 3,300,000

**AP66921
AP66821**

PPT Remanufactured G2.9 Injector*
PPT New G2.9 Injector*

OEM Part Numbers: 1848721C93, 4307212R91, 5010823R91, 6913-PP, 6930-PP

Notes: Installation requires removal of high-pressure oil rail. Use AP0025 High-Pressure Oil Rail Seal Kit when reinstalling oil rail.

Year Range: 2007-2010 Application: MaxxFORCE 9: 300 HP to 330 HP ESN Range: 3,000,001 to 3,300,000
2007-2010 MaxxFORCE 10: 310 HP to 350 HP 3,000,001 to 3,300,000

**AP66955
AP66855**



PPT Remanufactured G2.9 Injector*
PPT New G2.9 Injector*

OEM Part Numbers: 1890055C92, 1890056C2, 5010715R91, 6915-PP, 6932-PP

Notes: Installation requires removal of high-pressure oil rail. Use AP0025 High-Pressure Oil Rail Seal Kit when reinstalling oil rail.

Year Range: 2010-2014 Application: MaxxFORCE DT: 215 HP to 300 HP

**AP66957
AP66857**

PPT Remanufactured G2.9 Injector*
PPT New G2.9 Injector*

OEM Part Numbers: 1884057C92, 1884058C2, 5010986R91, 6914-PP, 6931-PP

Notes: Installation requires removal of high-pressure oil rail. Use AP0025 High-Pressure Oil Rail Seal Kit when reinstalling oil rail.

Year Range: 2010-2014 Application: MaxxFORCE DT: 210 HP to 225 HP

**AP66958
AP66858**

PPT Remanufactured G2.9 Injector*
PPT New G2.9 Injector*

OEM Part Numbers: 1890057C92, 1890058C2, 5010717R91, 6916-PP, 6933-PP

Notes: Installation requires removal of high-pressure oil rail. Use AP0025 High-Pressure Oil Rail Seal Kit when reinstalling oil rail.

Year Range: 2010-2014 Application: MaxxFORCE 9: 300 HP to 330 HP
2010-2014 MaxxFORCE 10: 310 HP to 350 HP
2015-2017 N9 / N10

DT466/570 HT570, MAXXFORCE DT/9/10, N9/N10

Engine Components

Water Pump

OEM Part Numbers: 1842664C92, 1842665C93

Notes: Includes mounting gasket.

Year Range:	Application:
2004-2006	DT466 / 570, HT570
2007-2010	MaxxForce DT / 9 / 10



AP63582

12cc Remanufactured High-Pressure Oil Pump*

OEM Part Numbers: 1885043C92, 1885044C2, 1889323C93, 5010736R91, 5010755R92, 7093938C91

Notes: The corresponding AP63514 Injection Pressure Regulator (IPR) Valve is included.

Year Range:	Application:	ESN Range:
2010-2014	MaxxForce DT	3,300,001 to End



AP63690

16cc High-Pressure Oil Pump*

OEM Part Numbers: 1885045C92, 1885046C2, 1889324C92, 5010755R92, 7093939C91

Notes: The corresponding AP63514 Injection Pressure Regulator (IPR) Valve is included.

Year Range:	Application:	ESN Range:
2010-2014	MaxxForce 9 / 10	3,300,001 to End
2015-2017	N9 / N10	



AP63681

12cc Remanufactured High-Pressure Oil Pump*

OEM Part Numbers: 1883888C93, 1842424C2, 1871291C4, 1842423C97, 1871292C96, 1842614C91, 5011334R92

Notes: The corresponding AP63512 Injection Pressure Regulator (IPR) Valve and Fuel Supply Pump are included.

Year Range:	Application:	ESN Range:
2004-2006	DT466	2,000,001 to 2,999,999



AP63692

16cc Remanufactured High-Pressure Oil Pump*

OEM Part Numbers: 1885000C93, 1842426C2, 1842425C96, 1842617C91, 5011330R91

Notes: The corresponding AP63512 Injection Pressure Regulator (IPR) Valve and Fuel Supply Pump are included.

Year Range:	Application:	ESN Range:
2004-2006	DT570, HT570	2,000,001 to 2,999,999



AP63693

*Indicates products with a core charge.

DT466/570 HT570, MAXXFORCE DT/9/10, N9/N10

Engine Components continued

AP63694



12cc Remanufactured High-Pressure Oil Pump Kit*

OEM Part Numbers: 1876105C95, 1832093C2, 1879744C2, 1832092C92, 1879743C93

Notes: Includes updated high-pressure hose and fitting. The corresponding AP63513 Injection Pressure Regulator (IPR) Valve and Fuel Supply Pump are included.

Year Range: 2007-2010	Application: MaxxForce DT	ESN Range: 3,000,001 to 3,040,000
--------------------------	------------------------------	--------------------------------------

AP63695



16cc Remanufactured High-Pressure Oil Pump Kit*

OEM Part Numbers: 1882259C93, 1876106C94, 1832095C2, 1832094C92, 5011332R91

Notes: Includes updated high-pressure hose and fitting. The corresponding AP63513 Injection Pressure Regulator (IPR) Valve and Fuel Supply Pump are included. OEM part numbers for both the early and late 16cc Remanufactured High-Pressure Pumps (AP63695 and AP63697) supersede to 1882259C93. The ESN must be used to determine which Alliant Power part number is required.

Year Range: 2007-2010	Application: MaxxForce 9 / 10	ESN Range: 3,000,001 to 3,040,000
--------------------------	----------------------------------	--------------------------------------

EXCLUSIVEKITS

AP63696

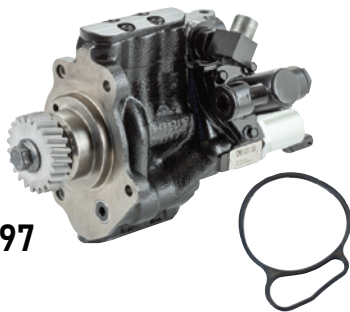

12cc Remanufactured High-Pressure Oil Pump*

OEM Part Numbers: 1882258C93, 1832093C2, 1879744C2, 1832092C92, 1879743C93

Notes: The corresponding AP63513 Injection Pressure Regulator (IPR) Valve and Fuel Supply Pump are included.

Year Range: 2007-2010	Application: MaxxForce DT	ESN Range: 3,040,001 to 3,300,000
--------------------------	------------------------------	--------------------------------------

AP63697

16cc Remanufactured High-Pressure Oil Pump*

OEM Part Numbers: 1882259C93, 1832095C2, 1832094C92, 1879747C2, 1879745C93

Notes: The corresponding AP63513 Injection Pressure Regulator (IPR) Valve and Fuel Supply Pump are included. OEM part numbers for both the early and late

16cc Remanufactured High-Pressure Pumps (AP63695 and AP63697) supersede to 1882259C93. The ESN must be used to determine which Alliant Power part number is required.

Year Range: 2007-2010	Application: MaxxForce 9 / 10	ESN Range: 3,040,001 to 3,300,000
--------------------------	----------------------------------	--------------------------------------

* Indicates products with a core charge.

DT466/570 HT570, MAXXFORCE DT/9/10, N9/N10

Sensors

Engine Speed/Position Sensor

OEM Part Number: 1828345C91

Notes: Camshaft Speed/Position.

Year Range:	Application:
2004-2006	DT466 / 570, HT570
2007-2010	MaxxForce DT / 9 / 10



AP63412

Engine Speed/Position Sensor

OEM Part Number: 1835985C92

Notes: Crankshaft Speed/Position.

Year Range:	Application:
2004-2006	DT466 / 570, HT570
2007-2010	MaxxForce DT / 9 / 10



AP63415

Exhaust Back Pressure (EBP) Sensor

OEM Part Number: 1846480C2

Year Range:	Application:
2007-2010	MaxxForce DT / 9 / 10

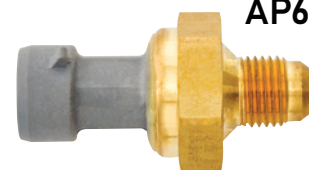

AP63423

Engine Oil Pressure (EOP) Sensor

OEM Part Numbers: 1839415C91, 1837802C1, 1839832C1, 1872556C91

Notes: AP0021 3 Wire Pigtail can be used to repair the harness connector.

Year Range:	Application:
2004-2007	DT466 / 570
2007-2013	MaxxForce DT / 9 / 10



AP63474

Engine Oil/Coolant/Fuel Temperature (EOT/ECT/FT) Sensor

OEM Part Number: 1836537C91

Year Range:	Application:
2004-2006	DT466 / 570, HT570
2007-2010	MaxxForce DT / 9 / 10

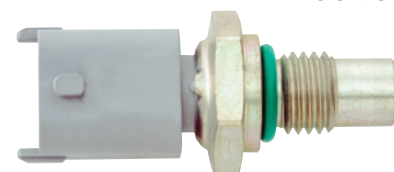

AP63437

Injection Control Pressure (ICP) Sensor

OEM Part Number: 1845536C91

Year Range:	Application:
2004-2007	DT466 / 570

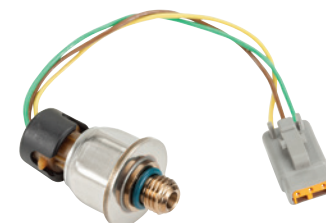

AP63567

DT466/570 HT570, MAXXFORCE DT/9/10, N9/N10

Sensors continued

AP63462

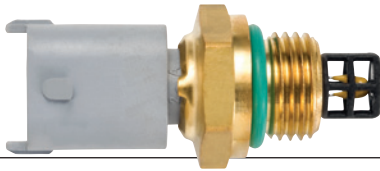

Intake Manifold Air Temperature (IAT) Sensor

OEM Part Number: 1836539C91

Year Range: 2004-2006 Application: DT466 / 570, HT570

AP63471



Exhaust Gas Recirculation (EGR) Temperature Sensor-Outlet

OEM Part Number: 1888560C1

Year Range: 2010-2011 Application: MaxxForce DT / 9 / 10

AP63476

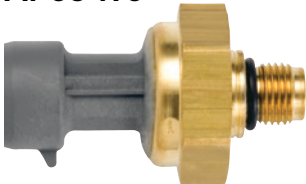

Manifold Absolute Pressure (MAP) Sensor

OEM Part Number: 1846481C92

Year Range: 2007-2011 Application: MaxxForce DT / 9 / 10

Actuators

AP63512



Injection Pressure Regulator (IPR) Valve

OEM Part Number: 1878571C95

Notes: Fits AP63692 12cc Remanufactured High-Pressure Oil Pump and AP63693 16cc Remanufactured High-Pressure Oil Pump. Includes valve and seal kit.

Year Range: 2004-2006 Application: DT466 / 570, HT570

AP63513



Injection Pressure Regulator (IPR) Valve

OEM Part Number: 1878629C95

Notes: Fits AP63694 12cc Remanufactured High-Pressure Oil Pump Kit, AP63695 16cc Remanufactured High-Pressure Oil Pump Kit, AP63696 12cc Remanufactured High-Pressure Oil Pump, and AP63697 16cc Remanufactured High-Pressure Oil Pump. Includes valve and seal kit.

Year Range: 2007-2010 Application: MaxxForce DT / 9 / 10

AP63514



Injection Pressure Regulator (IPR) Valve

OEM Part Number: 1889325C95

Notes: Fits AP63690 12cc Remanufactured High-Pressure Oil Pump and AP63681 16cc High-Pressure Oil Pump. Includes valve and seal kit.

Year Range: 2010-2014 Application: MaxxForce DT / 9 / 10
2015-2017 N9 / N10

DT466/570 HT570, MAXXFORCE DT/9/10, N9/N10

Electrical Harness and Repair

3 Wire Pigtail

AP0021

Notes: Fits AP63423 Exhaust Back Pressure (EBP) Sensor and AP63476 Manifold Absolute Pressure (MAP) Sensor.

Year Range: 2004-2006
2007-2010

Application: DT466 / 570, HT570
MaxxForce DT / 9 / 10



2 Wire Pigtail

AP0056

Notes: Fits AP63437 Engine Oil/Coolant/Fuel Temperature (EOT/ECT/FT) Sensor and AP63462 Intake Manifold Air Temperature (IAT) Sensor.

Year Range: 2004-2006
2007-2010

Application: DT466 / 570, HT570
MaxxForce DT / 9 / 10



Fuel Injection Control Module (FICM) Connector

AP0018

Notes: Field data shows identification marks 1456315-6, 1437287-7, or X-3.

Year Range: 2004-2006

Application: DT466 / 570, HT570

EXCLUSIVEPARTS

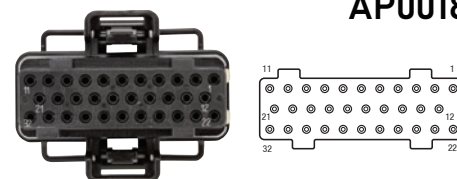

Fuel Injection Control Module (FICM) Connector

AP0019

Notes: Field data shows identification marks 1456315-2, 1437287-6, or X-2.

Year Range: 2004-2006

Application: DT466 / 570, HT570

EXCLUSIVEPARTS

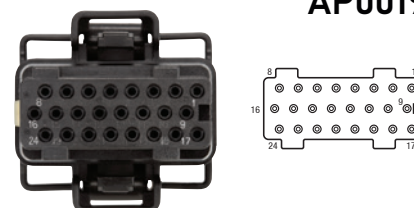

Fuel Injection Control Module (FICM) Connector

AP0020

Notes: Field data shows identification marks 1456316-1, 1437287-5, or X-1.

Year Range: 2004-2006

Application: DT466 / 570, HT570

EXCLUSIVEPARTS

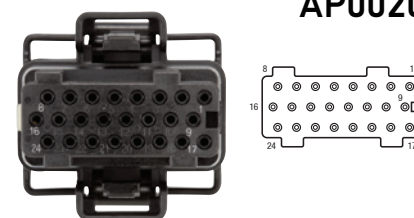

2 Wire Pigtail

AP0068

Notes: Fits the Injection Pressure Regulator (IPR) Valves.

Year Range: 2004-2006
2007-2013

Application: DT466 / 570, HT570
MaxxForce DT / 9 / 10





GM

6.5L

Fuel System Components

AP63440



Fuel Transfer Pump

OEM Part Numbers: 25117340, EP309

Year Range:	Engine:
1994-1999	6.5L

AP63441



Fuel Transfer Pump

OEM Part Numbers: 15754298, EP1000

Year Range:	Engine:
1999-2002	6.5L

Engine Components

AP63560



Water Pump

OEM Part Numbers: 12530176, 19168610, 88894036, 251-590

Notes: Includes mounting gasket. Field data indicates both Water Pumps (AP63560 and AP63561) were used for MY 1999 vehicles. Be sure to verify which Water Pump is in place. Used for bolt-on pulley applications.

Year Range:	Engine:
1994-1999	6.5L F, S, or Y

AP63561



Water Pump

OEM Part Numbers: 12556231, 88894035, 251-603, 252-776

Notes: Includes mounting gasket. Field data indicates both Water Pumps (AP63560 and AP63561) were used for MY 1999 vehicles. Be sure to verify which Water Pump is in place. Used for press-on pulley applications.

Year Range:	Engine:
1999-2003	6.5L

6.5L

Sensors

Engine Oil Pressure (EOP) Switch

OEM Part Numbers: 12555492, D1808A

Year Range: 1992-2002 Engine: 6.5L

AP63419

**Crankshaft Position (CKP) Sensor**

OEM Part Numbers: 12557046, 213-337

Year Range: 1994-2002 Engine: 6.5L

AP63444



Actuators

Glow Plug Relay

OEM Part Numbers: 12496472, 212-366, RY383

Year Range: 1994-2002 Engine: 6.5L

AP63420

**Turbo Wastegate Solenoid**

OEM Part Numbers: 1997227, 214-1073

Year Range: 1994-2002 Engine: 6.5L

AP63443

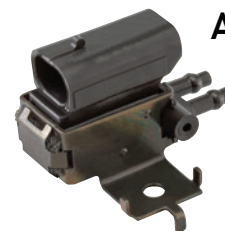

Electrical Harness and Repair

Engine Oil Pressure (EOP) Switch Connector Pigtail

OEM Part Numbers: 12085499, PT121

Year Range: 1992-2002 Engine: 6.5L

AP0022

**DS Pump 8" Wiring Harness Extension**

Year Range: 1994-2002 Engine: 6.5L

EXCLUSIVE PARTS AP0024

6.5L

Electrical Harness and Repair continued

AP0034



Turbo Wastegate Solenoid Connector Pigtail

Year Range:
1994-2002Engine:
6.5L

AP0067



Glow Plug Wire Harness Extension

OEM Part Number: 15320904

Year Range:
1994-2002Engine:
6.5L

Seal and Gasket Kits

APE65110

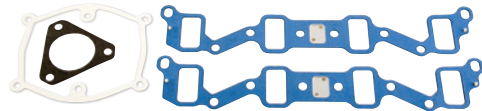

DS Pump Installation Kit

Year Range:
1992-2002Engine:
6.5L

EXCLUSIVEKITS

Engine Accessories

AP63701



Vacuum Pump-Mechanical

OEM Part Numbers: 7849209, 215-115

Notes: Also fits 6.2L.

Year Range:
1988-1995Engine:
6.5L

AP63702



Vacuum Pump-Mechanical

OEM Part Numbers: 89017558, 215-479

Year Range:
1996-2002Engine:
6.5L

6.5L

DS Pump Components

PMD & Harness Kit

OEM Part Number: 35976

Year Range:
1994-2002Engine:
6.5L**EXCLUSIVEKITS** AP63485**PMD Kit**

OEM Part Number: 40736

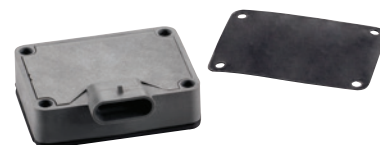
Year Range:
1994-2002Engine:
6.5L**EXCLUSIVEKITS** AP63486**EXCLUSIVEPARTS**

AP part number	Description	OEM part number
AP63546	Data Track Disc	30273
AP63547	Armature Plate Cover	30486
AP63548	ESO Actuator	33072
AP63549	Encoder Sensor	33883
AP63550	Stepper Motor Kit	34407
AP63551	Solenoid Assembly	36394
AP63552	Armature Assembly	39479
AP63553	Calibration Resistor #1	39859
AP63554	Calibration Resistor #2	39860
AP63555	Calibration Resistor #3	39861
AP63556	Calibration Resistor #4	39862
AP63557	Calibration Resistor #5	39863
AP63558	Calibration Resistor #6	39864
AP63559	Calibration Resistor #7	39865
AP63564	Calibration Resistor #8	39866
AP63565	Calibration Resistor #9	39867
AP0095	Overhaul Gasket Kit	33815

6.6L DURAMAX

Fuel System Components

AP63442



Fuel Transfer Pump

OEM Part Numbers: 15161174, EP1001, EP1020, 15821962 , 23484581, EP1037, 23495127

Year Range:
2001-2014

Engine:
6.6L Duramax

AP0059



Fuel Return Line Banjo Bolt

OEM Part Number: 97228929

Year Range:
2001-2004

Engine:
6.6L LB7 Duramax

EXCLUSIVE PARTS

AP63720



Injection Line

OEM Part Number: 97188720

Notes: Cylinders 1 and 8.

Year Range:
2001-2004

Engine:
6.6L LB7 Duramax

AP63721



Injection Line

OEM Part Number: 97188721

Notes: Cylinders 3 and 6.

Year Range:
2001-2004

Engine:
6.6L LB7 Duramax

AP63722



Injection Line

OEM Part Number: 97188722

Notes: Cylinders 4 and 5.

Year Range:
2001-2004

Engine:
6.6L LB7 Duramax

AP63723



Injection Line

OEM Part Number: 97188723

Notes: Cylinders 2 and 7.

Year Range:
2001-2004

Engine:
6.6L LB7 Duramax

6.6L DURAMAX

Engine Components

Turbo Hose

OEM Part Numbers: 15019994, 15019995

Year Range: 2001-2004
Engine: 6.6L LB7 Duramax**AP63457****Water Pump**

OEM Part Numbers: 97216136, 19113733, 19168888, 252-838, 251-674, 251-723

Notes: Includes mounting gaskets.

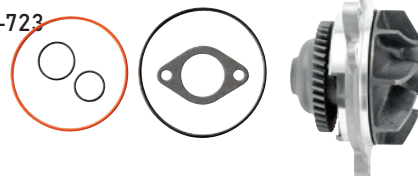
Year Range: 2001-2005
Engine: 6.6L Duramax**AP63562****Water Pump**

OEM Part Numbers: 98031233, 251-738, 12637105

Notes: Includes mounting gaskets.

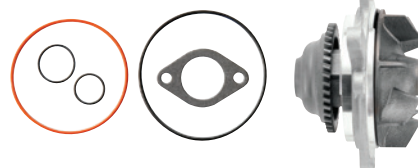
Year Range: 2006-2014
Engine: 6.6L Duramax**AP63563****Water Pump Housing**

OEM Part Number: 97228188

Notes: Fits AP63562 Water Pump.

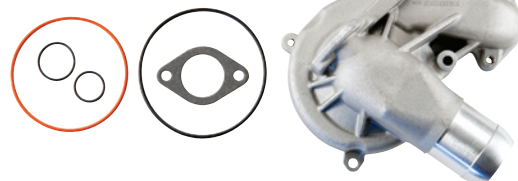
Year Range: 2001-2005
Engine: 6.6L LB7, LLY Duramax**AP63566**

Actuators

Turbocharger Vane Actuator

OEM Part Numbers: 98061571, 792593-0001

Year Range: 2004½-2010
2004-2009
Engine: 6.6L LLY, LBZ, LMM Duramax
6.6L TopKick / Kodiak 4500 / 5500**AP91000**

Electrical Harness and Repair

2 Wire Pigtail

Notes: Fits AP91000 Turbocharger Vane Actuator

Year Range: 2004½-2012
Engine: 6.6L LLY, LBZ, LMM, LML, LGH Duramax**AP0068****EXCLUSIVE PARTS**

6.6L DURAMAX

Seal and Gasket Kits

AP0029 **EXCLUSIVEKITS**

Fuel Filter Base and Hand Primer Seal Kit

Year Range:
2001-2016

Engine:
6.6L Duramax



AP0045 AP0062 **EXCLUSIVEKITS**

Head Installation Kit with Studs** Head Installation Kit without Studs

Notes: Head Gaskets sold separately refer to AP0047-AP0052.

Year Range:
2001-2004

Engine:
6.6L LB7 Duramax

Kit Contents:

- 2 Lower Valve Cover Gaskets
- 1 Exhaust Manifold Gasket Kit
- 1 Intake Manifold Gasket Kit
- 2 Thermostat Housing to Head Gaskets
- 1 Exhaust Gas Recirculation (EGR) System Gasket Kit
- 1 Water Pump to Outlet Pipe Gasket
- 1 Fuel Return Line Kit
- 16 Injector Cup Seals
- 1 Turbo Inlet Gasket
- 1 Coolant Bypass Pipe Seal Kit
- 1 Thermostat Housing to Coolant Outlet Pipe Seal
- 1 Thermostat Housing to Heater Pipe Seal
- 2 Fuel Injection Control Module (FICM) Banjo Seals
- **Includes Head Stud

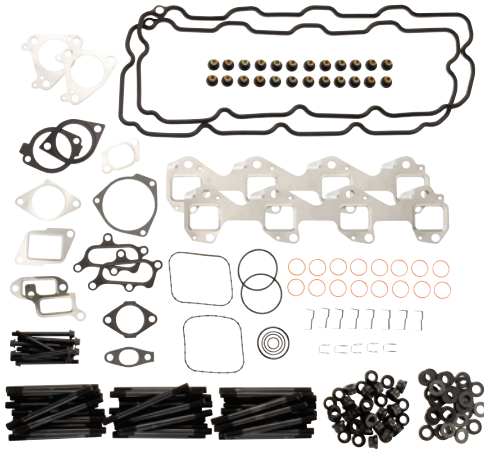

AP0046 AP0063 **EXCLUSIVEKITS**

Head Installation Kit with Studs** Head Installation Kit without Studs

Notes: Head Gaskets sold separately refer to AP0047-AP0052.

Year Range:
2004½-2010

Engine:
6.6L LLY, LBZ, LMM Duramax

Kit Contents:

- 2 Upper Valve Cover Gaskets
- 2 Lower Valve Cover Gaskets
- 1 Exhaust Manifold Gasket Kit
- 1 Intake Manifold Gasket Kit
- 2 Thermostat Housing to Head Gaskets
- 1 Exhaust Gas Recirculation (EGR) System Gasket Kit
- 1 Water Pump to Outlet Pipe Gasket
- 1 Coolant Bypass Pipe Seal Kit
- 1 Thermostat Housing to Coolant Outlet Pipe Seal
- 1 Thermostat Housing to Exhaust Gas Recirculation (EGR) Cooler Pipe Seal
- 2 Fuel Injection Control Module (FICM) Banjo Seals
- **Includes Head Stud

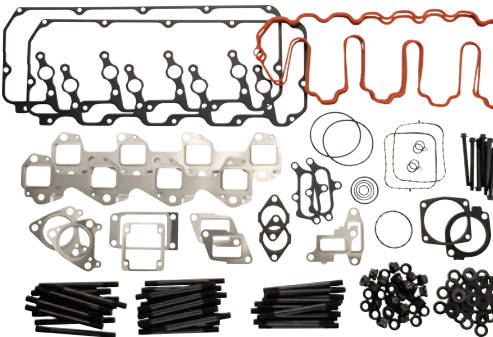

6.6L DURAMAX

continued Seal and Gasket Kits

Head Gasket Kit with Studs** Head Gasket Kit without Studs

Notes: Head Gaskets sold separately refer to AP0047-AP0052.

Year Range: 2011-2016 Engine: 6.6L LML Duramax Application: Silverado and Sierra Vehicles

Kit Contents:

- 2 Upper Valve Cover Gaskets
- 2 Lower Valve Cover Gaskets
- 2 Exhaust Manifold Gasket Kits
- 2 Intake Manifold Gasket Kits
- 1 Coolant Outlet Gasket
- 1 Coolant Thermostat Housing Gasket
- 1 Fuel Injection Throttle Body Gasket Kit
- **Includes Head Stud Kit



EXCLUSIVE KITS AP0154
AP0155

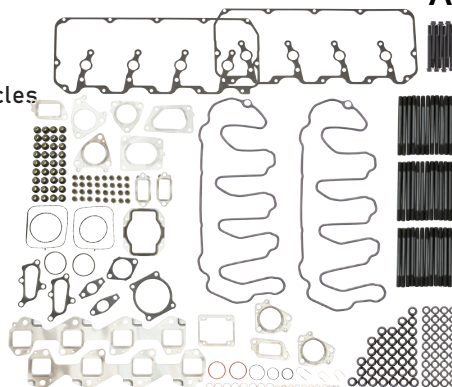

Head Gasket

AP0047

OEM Part Numbers: 98045058, 12637787

Notes: 0.95 mm, Grade A, left.

Year Range: 2001-2015 Engine: 6.6L Duramax

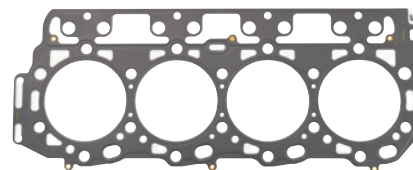

Head Gasket

AP0048

OEM Part Numbers: 98045059, 12637786

Notes: 1.00 mm, Grade B, left.

Year Range: 2001-2015 Engine: 6.6L Duramax

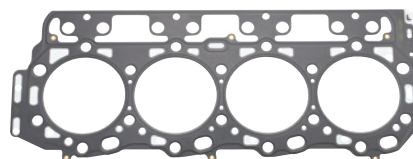

Head Gasket

AP0049

OEM Part Numbers: 98045060, 12637785

Notes: 1.05 mm, Grade C, left.

Year Range: 2001-2015 Engine: 6.6L Duramax

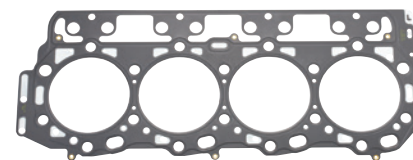

Head Gasket

AP0050

OEM Part Numbers: 98045055, 12637790

Notes: 0.95 mm, Grade A, right.

Year Range: 2001-2015 Engine: 6.6L Duramax

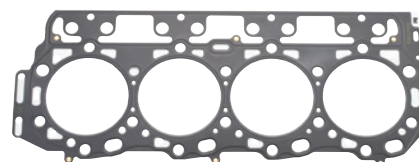

Head Gasket

AP0051

OEM Part Numbers: 98045056, 12637789

Notes: 1.00 mm, Grade B, right.

Year Range: 2001-2015 Engine: 6.6L Duramax

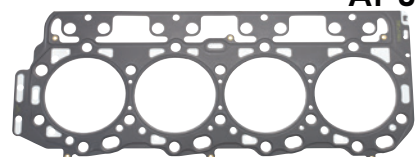

6.6L DURAMAX

Seal and Gasket Kits continued

AP0052

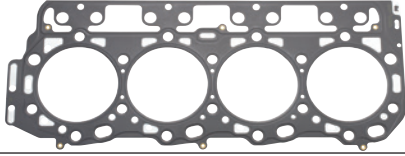

Head Gasket

OEM Part Numbers: 98045057, 12637788

Notes: 1.05 mm, Grade C, right.

Year Range:
2001-2015

Engine:
6.6L Duramax

AP0127 **NEXCLUSIVEKITS**

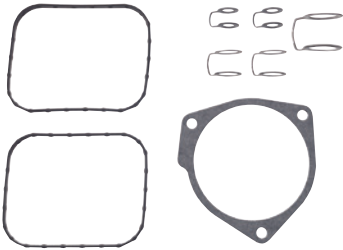

High-Pressure Fuel Pump Installation Kit

Year Range:
2001-2004
Vehicles

Engine:
6.6L LB7 Duramax

Application:
Silverado and Sierra

AP0128 **NEXCLUSIVEKITS**

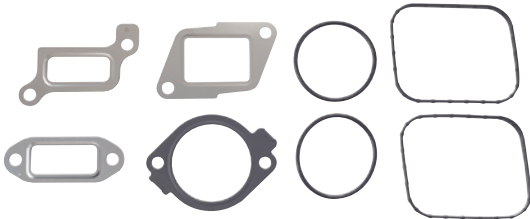

High-Pressure Fuel Pump/Exhaust Gas Recirculation (EGR) Valve Installation Kit

Year Range:
2004½-2005
Vehicles

Engine:
6.6L LLY Duramax

Application:
Silverado and Sierra

NEXCLUSIVEKITS

AP0129

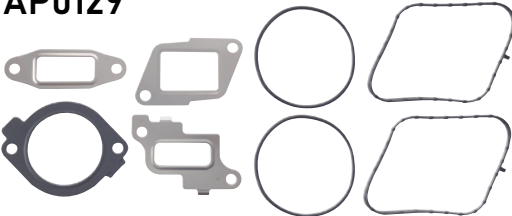

High-Pressure Fuel Pump/Exhaust Gas Recirculation (EGR) Valve Installation Kit

Year Range:
2006-2007
Vehicles

Engine:
6.6L LBZ Duramax

Application:
Silverado and Sierra

NEXCLUSIVEKITS

AP0130

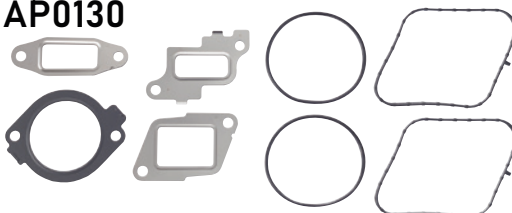

High-Pressure Fuel Pump/Exhaust Gas Recirculation (EGR) Valve Installation Kit

Year Range:
2007-2010

Engine:
6.6L LMM Duramax

Application:
Silverado and Sierra Vehicles

6.6L DURAMAX

continued Seal and Gasket Kits

Turbo Installation Kit

Year Range: 2001–2010
 Engine: 6.6L LB7, LLY, LBZ, LMM Duramax

AP0162

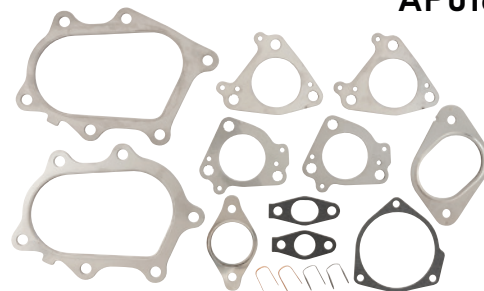

Engine Accessories

Belt Tensioner

OEM Part Numbers: 97329062, 38172, 89003343, 98094201, 97288625
 Year Range: 2002–2016
 Engine: 6.6L Duramax

AP63449



Starter

OEM Part Numbers: 88864234, 336–1737
 Year Range: 2003–2011
 Engine: 6.6L Duramax

S14-101DAM



Filters

Oil Filter

OEM Part Numbers: 88917036, PF2232
 Year Range: 2001 and Later
 Engine: 6.6L LB7, LLY, LBZ, LMM, LML, LGH Duramax
 Application: Silverado and Sierra Vehicles

PFL5515



RACOR

Fuel Filter Assembly

OEM Part Number: 12642623
 Year Range: 2004½–2011
 Engine: 6.6L LLY, LBZ, LMM, LML Duramax
 Application: Silverado and Sierra Vehicles

PFF4245R2-02



RACOR

6.6L DURAMAX

Filters continued

PFF50216



RACOR

Spin-on Fuel Filter

OEM Part Numbers: 98017645, TP1298B, TP3018

Year Range:
2001-2016
Vehicles

Engine:
6.6L Duramax

Application:
Silverado and Sierra

PFF58567



RACOR

Fuel Filter Service Kit

Notes: Primary and secondary.

Year Range:
2004-2012
Vehicles

Engine:
6.6L Duramax

Application:
Express and Savana Vehi-
cles

RK58010

RACOR



Replacement Plastic Bowl with Drain and WIF Sensor

OEM Part Number: 19257915

Notes: Use with PFF58567 Fuel Filter Service Kit. Van applications only.

Year Range:
2004-2012
Vehicles

Engine:
6.6L Duramax

Application:
Express and Savana Vehi-
cles



BOLINGBROOK, IL 815.886.9900	PALATINE, IL 847.991.7867	PERU, IL 815.224.3439	CHICAGO, IL 773.475.9000	ROCKDALE, IL 815.744.7800	AGAWAM, MA 413.789.6600	ALLENTOWN, PA 610.395.3718
DEEP RIVER, CT 860.526.5941	PORTLAND, OR 503.283.5615	ALBANY, OR 541.248.3802	BOCA RATON, FL 561.241.0242	CONCORD, NC 704.721.6661	WASHINGTON, DC 708.514.2016	VISIT US ONLINE: SeidelDiesel Group.com

6.6L DURAMAX

continued Filters

Drain Valve/Water Sensor Kit

Year Range:
2001-2011Engine:
6.6L Duramax

RK42043



Drain Valve/Water Sensor Kit

OEM Part Number: 12651583

Year Range:
2012 and LaterEngine:
6.6L LML, LGH Duramax

PFRK50309



Water Repelling Prescreen Filter

OEM Part Number: 19259252

Notes: Includes chassis cab and full size van (GMT 610).

Year Range:
2012 and LaterEngine:
6.6L LGH DuramaxApplication:
Express and Savana Vehicles

PFFRK51216



Diesel Fuel Treatments from the Diesel Experts



DODGE/CUMMINS

ENGINES WITH PT PUMPS

Fuel System Components

AP3035342

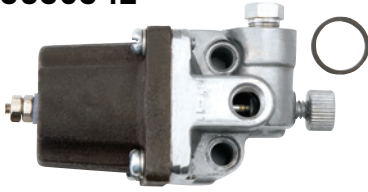

Fuel Shut-off Valve Assembly-12 Volt

OEM Part Number: 3035342

Year Range: N/A Engine: PT Pumps

AP3035344

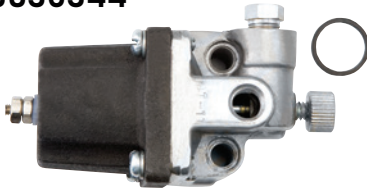

Fuel Shut-off Valve Assembly-24 Volt

OEM Part Number: 3035344

Year Range: N/A Engine: PT Pumps

AP4024808

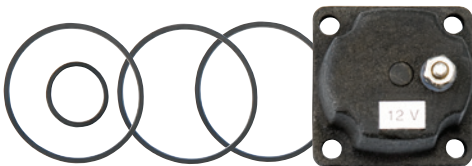

Fuel Shut-off Coil-12 Volt

OEM Part Number: 4024808

Year Range: N/A Engine: PT Pumps

AP4024809

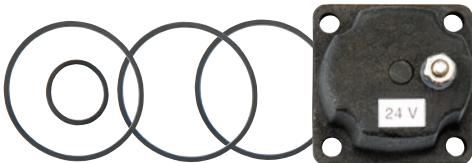

Fuel Shut-off Coil-24 Volt

OEM Part Number: 4024809

Year Range: N/A Engine: PT Pumps



BOLINGBROOK, IL 815.886.9900	PALATINE, IL 847.991.7867	PERU, IL 815.224.3439	CHICAGO, IL 773.475.9000	ROCKDALE, IL 815.744.7800	AGAWAM, MA 413.789.6600	ALLENTOWN, PA 610.395.3718
DEEP RIVER, CT 860.526.5941	PORTLAND, OR 503.283.5615	ALBANY, OR 541.248.3802	BOCA RATON, FL 561.241.0242	CONCORD, NC 704.721.6661	WASHINGTON, DC 708.514.2016	VISIT US ONLINE: SeidelDiesel Group.com

5.9L

Fuel System Components

Fuel Transfer Pump

OEM Part Numbers: 3901425, 3904374, 3928143, 3966154, 3970880, 4983584

Year Range: 1989-1993 Engine: 5.9L B-Series, 12-Valve

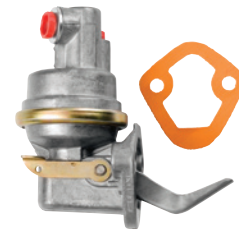

AP63478

Fuel Transfer Pump Kit

OEM Part Numbers: 3936316, 4988747, 4944710

Notes: Includes two mounting gaskets.

Year Range: 1994-1998 Engine: 5.9L B-Series, 12-Valve

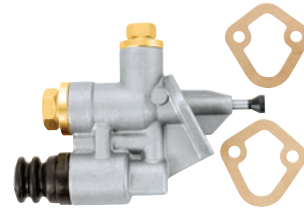

AP4988747

Fuel Transfer Pump Kit

OEM Part Numbers: 3990082, 3990105, 4932707, 4935730

Year Range: 1998-2003 Engine: 5.9L ISB with VP44

EXCLUSIVEKITS



AP4943048

Fuel Transfer Pump Kit

OEM Part Number: 3969705 (Hose)

Year Range: 2003-2004 Engine: 5.9L ISB with Common Rail

EXCLUSIVEKITS



AP4089602

Engine Components

Oil Cooler

OEM Part Numbers: 3921558, 3957544, 4713985AB

Year Range: 1993-1998 Engine: 5.9L B-Series, 12-Valve
1998-2003 Engine: 5.9L ISB with VP44

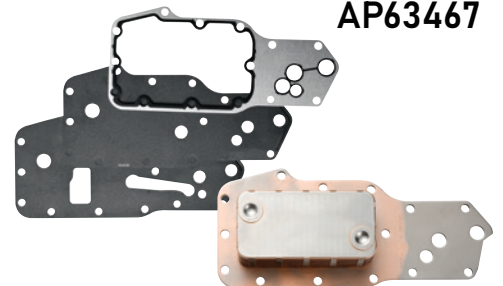

AP63467

EXCLUSIVEKITS



5.9L

Engine Components continued

AP63531

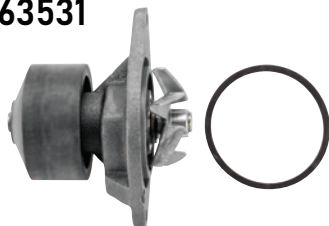

Water Pump

OEM Part Numbers: 3286278, 3286277

Notes: Includes mounting gasket. Supersedes AP63530 Water Pump.

Year Range:
1990-1998
1998-2003

Engine:
5.9L B-Series, 12-Valve
5.9L ISB with VP44

AP63532

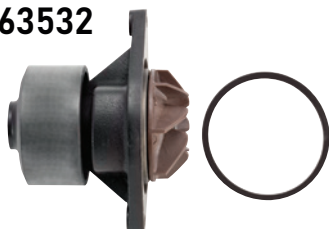

Water Pump

OEM Part Numbers: 3800984, 4891252

Notes: Includes mounting gasket.

Year Range:
2003-2007

Engine:
5.9L ISB with Common Rail

Sensors

AP63428



Accelerator Pedal Position Sensor (APPS)

OEM Part Numbers: 3970084, 53031575AH

Notes: For use with automatic transmissions.

Year Range:
1998-2003

Engine:
5.9L ISB with VP44

AP63427



Accelerator Pedal Position Sensor (APPS)

OEM Part Numbers: 3970085, 53031576AD

Notes: For use with manual transmissions.

Year Range:
1998-2003

Engine:
5.9L ISB with VP44

AP63458



Accelerator Pedal Position Sensor (APPS)

Notes: For use with automatic or manual transmissions.

Year Range:
1998-2003
2003-2004

Engine:
5.9L ISB with VP44
5.9L ISB with Common Rail

EXCLUSIVE PARTS

5.9L

continued Sensors

Crankshaft Position (CKP) Sensor

OEM Part Number: 4921601

Year Range: 1998-2003 Engine: 5.9L ISB with VP44

AP63453

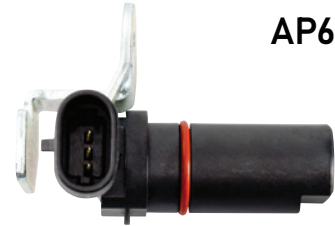

Seal and Gasket Kits

Valve Cover Gasket

OEM Part Numbers: 3935878, 5016356AB

Year Range: 1998-2003 Engine: 5.9L ISB with VP44

AP0012



Intake Grid Heater Gaskets

OEM Part Number: 3969988

Year Range: 1989-1998 Engine: 5.9L B-Series, 12-Valve
 1998-2003 Engine: 5.9L ISB with VP44
 2003-2006 Engine: 5.9L ISB with Common Rail

AP0058

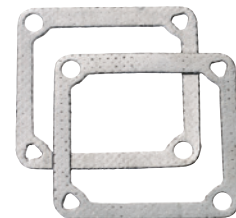

Head Gasket Kit with Studs
 Head Gasket Kit without Studs**

Notes: Standard head gasket.

Year Range: 1998-2003 Engine: 5.9L ISB with VP44

Kit Contents:

- 1 Head Gasket
- 1 Valve Cover Gasket
- 6 Exhaust Manifold Gaskets
- 1 Intake Manifold Gasket Set
- 1 Turbo Gasket Set
- 1 Coolant Outlet Gasket
- **Includes Head Studs



EXCLUSIVE KITS AP0053
 AP0092

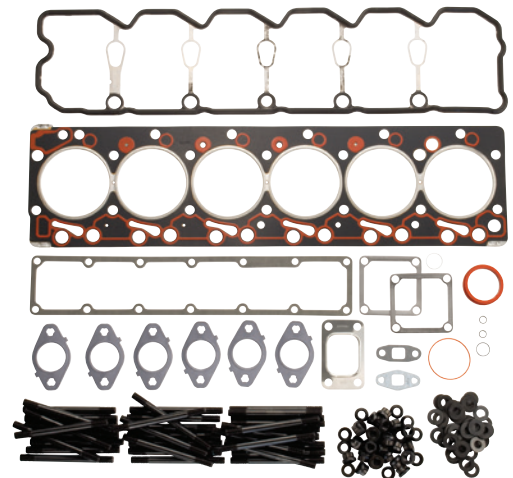

5.9L

Seal and Gasket Kits continued

AP0054
AP0093 **EXCLUSIVE KITS**

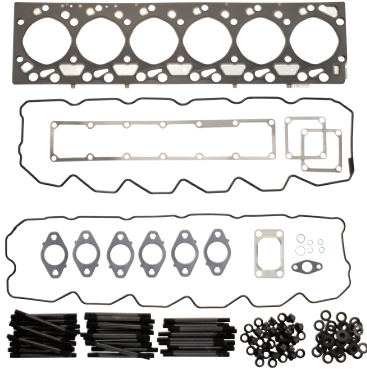

Head Gasket Kit with Studs**
Head Gasket Kit without Studs

Notes: 1.10 mm head gasket.

Year Range: 2003–2006 Engine: 5.9L ISB with Common Rail

Kit Contents:

- 1 Head Gasket
- 1 Valve Cover Gasket
- 1 Rocker Housing Gasket
- 6 Exhaust Manifold Gaskets
- 1 Intake Manifold Gasket Set
- 1 Turbo Gasket Set
- **Includes Head Studs



AP0055
AP0094 **EXCLUSIVE KITS**

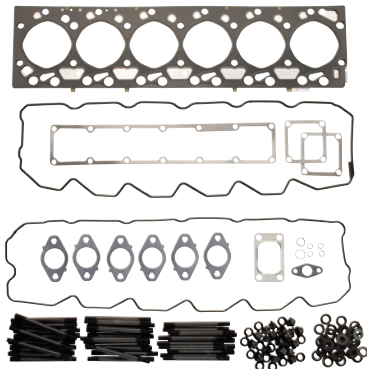

Head Gasket Kit with Studs**
Head Gasket Kit without Studs

Notes: 1.20 mm head gasket.

Year Range: 2003–2006 Engine: 5.9L ISB with Common Rail

Kit Contents:

- 1 Head Gasket
- 1 Valve Cover Gasket
- 1 Rocker Housing Gasket
- 6 Exhaust Manifold Gaskets
- 1 Intake Manifold Gasket Set
- 1 Turbo Gasket Set
- **Includes Head Studs



Engine Accessories

228000–2292



Starter

OEM Part Numbers: 3921682, 5016522AA

Year Range: 1994–1998 Engine: 5.9L B-Series, 12-Valve
1998–2002 Engine: 5.9L ISB with VP44

428000–5940



Starter

OEM Part Numbers: 4090084, 5086932AA

Year Range: 2003–2006 Engine: 5.9L ISB with Common Rail

5.9L

Filters

Fuel Filter Element

OEM Part Numbers: 4883963AC, 3990130

Notes: Includes filters for mechanical P Pump and VP44 fuel system.

Year Range:	Engine:
1997-1998	5.9L ISB with P Pump
1998½-1999	5.9L ISB with VP44



PFF19528

RACOR



Fuel Filter Element

OEM Part Numbers: 5015581AA, 4941252

Notes: Includes filters for VP44 and high-pressure common rail (HPCR) fuel system.

Year Range:	Engine:
2000-2002	5.9L ISB with VP44
2003-2010	5.9L ISB with Common Rail



PFF19579

RACOR



BOLINGBROOK, IL 815.886.9900	PALATINE, IL 847.991.7867	PERU, IL 815.224.3439	CHICAGO, IL 773.475.9000	ROCKDALE, IL 815.744.7800	AGAWAM, MA 413.789.6600	ALLENTOWN, PA 610.395.3718
DEEP RIVER, CT 860.526.5941	PORTLAND, OR 503.283.5615	ALBANY, OR 541.248.3802	BOCA RATON, FL 561.241.0242	CONCORD, NC 704.721.6661	WASHINGTON, DC 708.514.2016	VISIT US ONLINE: SeidelDiesel Group.com



6.7L

Engine Components

AP63533

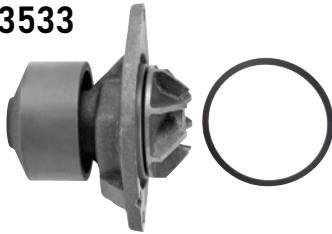

Water Pump

OEM Part Numbers: 2881804, 68003402AA, 4955359

Notes: Includes mounting gasket.

Year Range: 2007-2012 Engine: 6.7L ISB

Seal and Gasket Kits

AP0091 **EXCLUSIVE KITS**
AP0097

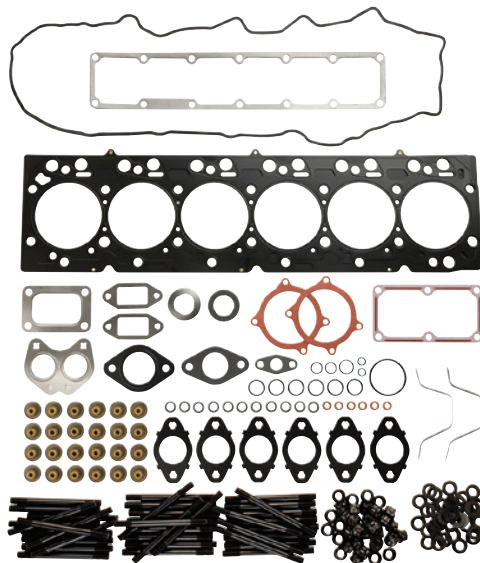

Head Gasket Kit with Studs** Head Gasket Kit without Studs

Year Range: 2007-2013 Engine: 6.7L ISB 2500 / 3500
2007-2009 Engine: 6.7L ISB 4500 / 5500

Kit Contents:

- 1 Head Gasket
- 1 Valve Cover Gasket
- 6 Exhaust Manifold Gaskets
- 1 Intake Manifold Gasket
- 1 Turbo Gasket Set
- **Includes Head Studs



BOLINGBROOK, IL 815.886.9900	PALATINE, IL 847.991.7867	PERU, IL 815.224.3439	CHICAGO, IL 773.475.9000	ROCKDALE, IL 815.744.7800	AGAWAM, MA 413.789.6600	ALLENTOWN, PA 610.395.3718
DEEP RIVER, CT 860.526.5941	PORTLAND, OR 503.283.5615	ALBANY, OR 541.248.3802	BOCA RATON, FL 561.241.0242	CONCORD, NC 704.721.6661	WASHINGTON, DC 708.514.2016	VISIT US ONLINE: SeidelDiesel Group.com

6.7L

Filters

Spin-on Fuel Filter/Water Separator

OEM Part Number: 68197867AA

Notes: Frame mounted filter.

Year Range: 2014 and Later Engine: 6.7L ISB with High-Pressure Common Rail (HPCR)

PFF54529



Drain Valve/Water Separator Kit

OEM Part Numbers: 68197868AA / AB

Notes: Frame mounted filter.

Year Range: 2013 and Later Engine: 6.7L ISB with High-Pressure Common Rail (HPCR)

PFRK54553



BOLINGBROOK, IL 815.886.9900	PALATINE, IL 847.991.7867	PERU, IL 815.224.3439	CHICAGO, IL 773.475.9000	ROCKDALE, IL 815.744.7800	AGAWAM, MA 413.789.6600	ALLENTOWN, PA 610.395.3718
DEEP RIVER, CT 860.526.5941	PORTLAND, OR 503.283.5615	ALBANY, OR 541.248.3802	BOCA RATON, FL 561.241.0242	CONCORD, NC 704.721.6661	WASHINGTON, DC 708.514.2016	VISIT US ONLINE: SeidelDiesel Group.com



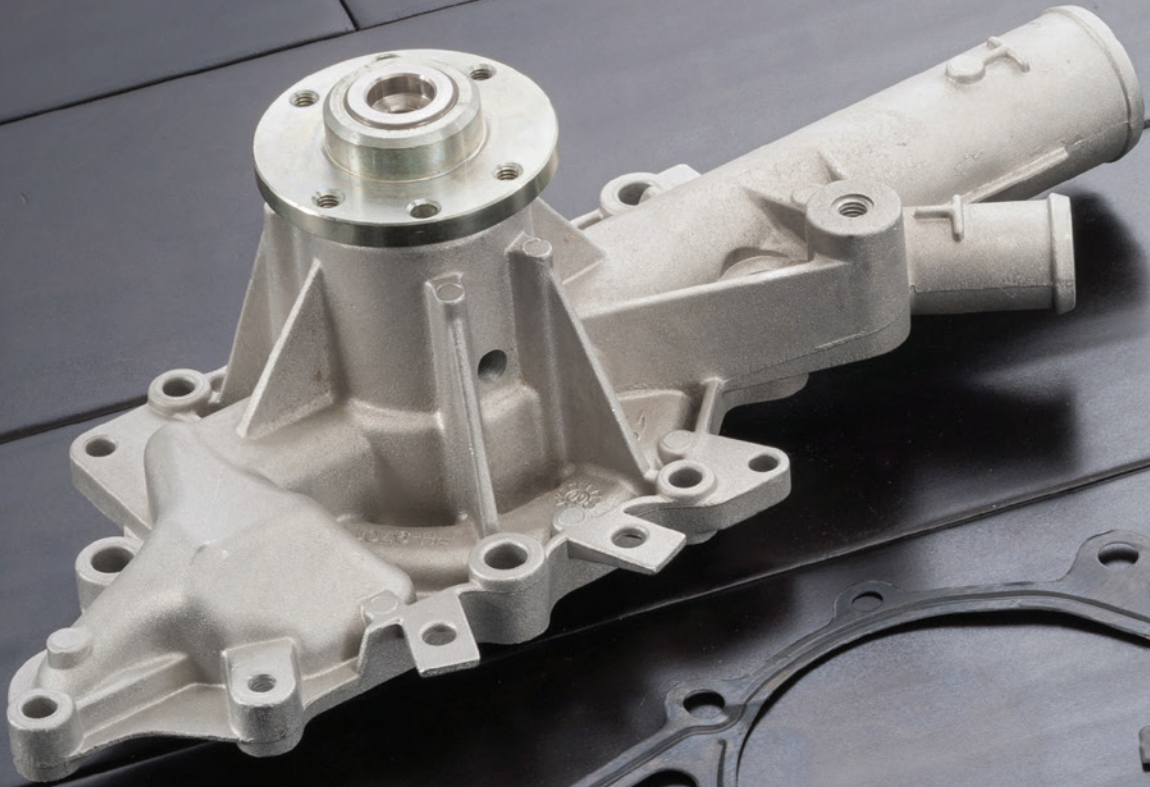



JEEP/SPRINTER

2.7L & 3.0L

Engine Components

AP63600

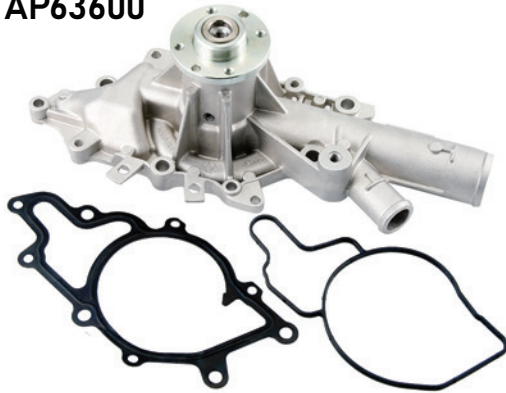

Water Pump

OEM Part Numbers: 5103576AA, 6112001101

Notes: Includes two mounting gaskets.

Year Range:
2002-2003

Engine:
2.7L OM 612

Application:
Sprinter 2500 / 3500

AP63601

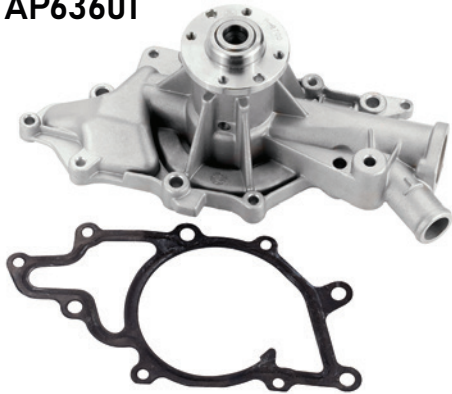

Water Pump

OEM Part Numbers: 5138057AA, 6472000101

Notes: Includes mounting gasket.

Year Range:
2004-2006

Engine:
2.7L OM 647

Application:
Sprinter 2500 / 3500

Filters

AP61000



Oil Filter Element Service Kit

OEM Part Numbers: 0011849425, 5086301AA, 1121840025, 6111800009, A6111800009

Year Range:
2002-2003
2004-2006

Engine:
2.7L OM 612
2.7L OM 647

Application:
Sprinter 2500 / 3500
Sprinter 2500 / 3500

AP61001



Oil Filter Element Service Kit

OEM Part Numbers: 5175571AA, 6421800009, A6421800009

Year Range:
2007-2014
2007-2008

Engine:
3.0L OM 642
3.0L OM 642

Application:
Sprinter 2500 / 3500
Jeep Grand Cherokee

2.7L & 3.0L

continued **Filters**

Fuel Filter without WIF Sensor

OEM Part Numbers: 5103577AA, 6120920001, A6120920001

Notes: WIF sensor can be transferred from old filter to new filter.

Year Range:	Engine:	Application:
2002-2003	2.7L OM 612	Sprinter 2500 / 3500



AP61002

Fuel Filter without WIF Sensor

OEM Part Numbers: 5117492AA, 5170896AB, 5175425AB, 5175429AB, 6460920701, 6460900252, 6460920201, 6460920601

Notes: WIF sensor can be transferred from old filter to new filter.

Year Range:	Engine:	Application:
2004-2006	2.7L OM 647	Sprinter 2500 / 3500
2007-2009	3.0L OM 642	Sprinter 2500 / 3500
2007-2008	3.0L OM 642	Jeep Grand Cherokee



AP61003

Fuel Filter without WIF Sensor

OEM Part Number: 6420920301

Notes: WIF sensor can be transferred from old filter to new filter.

Year Range:	Engine:	Application:
2010-2012	3.0L OM 642	Sprinter 2500 / 3500



AP61005



BOLINGBROOK, IL 815.886.9900	PALATINE, IL 847.991.7867	PERU, IL 815.224.3439	CHICAGO, IL 773.475.9000	ROCKDALE, IL 815.744.7800	AGAWAM, MA 413.789.6600	ALLENTOWN, PA 610.395.3718
DEEP RIVER, CT 860.526.5941	PORTLAND, OR 503.283.5615	ALBANY, OR 541.248.3802	BOCA RATON, FL 561.241.0242	CONCORD, NC 704.721.6661	WASHINGTON, DC 708.514.2016	VISIT US ONLINE: SeidelDiesel Group.com